

OIL AND GAS WELL SLOTTING PERFORATION PROFESSIONAL SERVICE

# MAXXWELL PRODUCTION

CONTINUOUS MOVING JET SLOTTING PERFORATION TECHNOLOGY FOR VERTICAL AND HORIZONTAL WELLS



**CORRESPONDENCE**

616 Corporate Way 2, # 4201  
Valley Cottage, NY  
United States 10989

**CORRESPONDENCE**

848 N. Rainbow Blvd., # 5353  
Las Vegas, NV  
United States 89107

**CORRESPONDENCE**

11555 US-380, # 205  
Krum, TX  
United States 76249

**PHONES**

Toll free: 1-800-696-5721  
Tel: (940) 368-1192  
(647) 724-4308

**EMAILS**

info@maxxwell.us  
info@maxxwell.ca  
info@maxxwell.net

**INTERNET**

www.maxxwell.us  
www.maxxwell.ca  
www.maxxwell.net



| Description   | page               |
|---|--------------------|
| <b>Introduction</b>   | <b>5</b>           |
| • Oil and Gas market condition  | <a href="#">5</a>  |
| • Recovery methods  | <a href="#">5</a>  |
| • Enhance Oil Recovery (EOR) ways   | <a href="#">5</a>  |
| • Hidden potentials   | <a href="#">5</a>  |
| • Geo-Mechanical phenomena  | <a href="#">6</a>  |
| • Unloading stress conditions in the near wellbore zone                               | <a href="#">6</a>  |
| <b>Hydro-slotting perforation (HSP) Technology</b>                                    | <b>7</b>           |
| • HSP. Concepts and benefits  | <a href="#">7</a>  |
| • Annual compressive stress conditions, and unloading ways                            | <a href="#">8</a>  |
| • Continuous slots (“windows”) along the wellbore                                     | <a href="#">9</a>  |
| • How to cut continuous slots along the wellbore ?                                    | <a href="#">10</a> |
| • Why abrasive jet (point hydro-jetting) perforation not increases the permeability ? | <a href="#">11</a> |
| • Benefits of continuous moving hydro-jetting (hydro-slotting) perforation            | <a href="#">12</a> |
| • Underground hydro-slotting perforation (HSP) equipment (Maxxwell-tool)              | <a href="#">12</a> |
| • Hydraulic slot-perforation tool it is very easy (Patent US 8863823)                 | <a href="#">13</a> |
| • Security and Safety of Maxxwell-tool  | <a href="#">14</a> |
| • Hydro-slotting perforation process. Well re-completion with HSP Technology          | <a href="#">15</a> |
| • Technical parameters for HSP  | <a href="#">16</a> |
| • Geometry of cutting slots   | <a href="#">17</a> |
| • What can be done with slotting perforation tool ?                                   | <a href="#">17</a> |
| • Results after operation of HSP tool/equipment                                       | <a href="#">18</a> |
| • Benefits from HSP in charts   | <a href="#">19</a> |
| • Where is HSP possible to use ?  | <a href="#">20</a> |
| • Example - thinly interbedded formation (chalk, shale, clays)                        | <a href="#">20</a> |
| • Example - crumbling sand (lose sand)  | <a href="#">21</a> |
| • Example - horizontal well   | <a href="#">21</a> |
| • Hydraulic fracturing and hydro-slotting perforation (HSP) comparison                | <a href="#">22</a> |
| • HSP it is not a magic wand for all occasions  | <a href="#">23</a> |
| • Cause of the fall of productive influx  | <a href="#">23</a> |
| • In which wells HSP can be used ?  | <a href="#">23</a> |
| • Which wells are preferable for HSP ?  | <a href="#">23</a> |
| <b>HSP Statistics (productive inflow Before HSP and after HSP)</b>                    | <b>24</b>          |
| • HSP Statistics (productive inflow Before HSP and after HSP)                         | <a href="#">24</a> |

| Description   | page               |
|---|--------------------|
| <b>Maxxwell Production - HSP service company</b>  | <b>25</b>          |
| • About us and our company  | <a href="#">26</a> |
| • Registrations (United States - Canada) office/workshop/laboratory, and representatives                                      | <a href="#">27</a> |
| • Management Team   | <a href="#">28</a> |
| • Intellectual properties (Patents <a href="#">US 8863823</a> , <a href="#">US 8240369</a> , <a href="#">US 20130105163</a> ) | <a href="#">29</a> |
| • Legality, professional liability, HSP experience, licensing, certifications, safety, PPE                                    | <a href="#">30</a> |
| • Maxxwell Production current Contracts   | <a href="#">31</a> |
| • Recent projects. References - well owners.  | <a href="#">32</a> |
| • HSP tool/equipment (Maxxwell-tool), consumables and spare parts   | <a href="#">33</a> |
| • HSP laboratory equipment, business and travel equipment   | <a href="#">34</a> |
| <b>Investment Project (low productive oil wells HSP re-completion)</b>  | <b>35</b>          |
| • Louisiana. Caddo deposit-field. Historical factor.  | <a href="#">36</a> |
| • Louisiana. Caddo deposit-field. Geological factor.  | <a href="#">37</a> |
| • Louisiana. Caddo deposit-field. Comparison of technologies.   | <a href="#">39</a> |
| • Louisiana. Caddo deposit-field. Technique.  | <a href="#">40</a> |
| <b>Financial Estimations (Summary)</b>  | <b>42</b>          |
| • Financial Estimations (Summary)   | <a href="#">42</a> |
| • Geophysical and Geological analysis. Prices and cost.   | <a href="#">43</a> |
| • Preparation, preparatory, and HSP process expenses. Prices and cost.  | <a href="#">44</a> |
| • Amortizations and current expenses. Prices and cost.  | <a href="#">45</a> |
| • Third-party services and equipment. Prices and cost.  | <a href="#">46</a> |
| • Re-completion of nearby injector well with HSP Technology. Prices and cost.   | <a href="#">47</a> |
| • Additional operations and expenses. Prices and cost.  | <a href="#">48</a> |
| • Final solutions on expenses, and increasing the productive inflow (by minimum)  | <a href="#">49</a> |
| • Price example: land with low productive well  | <a href="#">50</a> |
| • Investment in land with 3 wells (1 injection and 2 oil) with subsequent HSP re-completion                                   | <a href="#">51</a> |
| • Investment in land with 5 wells (2 injection and 3 oil) with subsequent HSP re-completion                                   | <a href="#">52</a> |
| • Investment in land with 10 wells (3 injection and 7 oil) with subsequent HSP re-completion                                  | <a href="#">53</a> |
| • Investment in HSP re-completion of 3 wells (1 injection and 2 oil) without purchase   | <a href="#">54</a> |
| • Investment in HSP re-completion of 5 wells (2 injection and 3 oil) without purchase   | <a href="#">55</a> |
| • Investment in HSP re-completion of 10 wells (3 injection and 7 oil) without purchase  | <a href="#">56</a> |
| • Generalization of the results   | <a href="#">57</a> |
| <b>Financial risks. Assessment of unexpected risks.</b>   | <b>58</b>          |
| • Financial risks. Assessment of unexpected risks.  | <a href="#">58</a> |



## OIL AND GAS MARKET CONDITION

In the article ‘Strippers’ Pose Dilemma for Oil Industry’ (The Wall Street Journal) from September 7, 2015, Nicole Friedman writes: “In the United States more than 400,000 stripper wells, most of which produce less than five barrels a day. They losing money every day. If oil prices will be held at the level off \$ 40 per barrel or below, more than half of stripper-well production could be shut down.

Thousands of individual operators could turn out to be a key element in ending the oil-price rout, rather than a large producing country like Saudi Arabia or a big public company. A sharp drop in stripper-well output, currently estimated at a million barrels a day, or 11 % of total U.S. production, would be nearly impossible to observe as it happens, but it could still shrink the glut that continues to weigh on prices, surprising the market”.

<http://www.wsj.com/articles/stripper-wells-are-wild-card-in-oil-rout-1441660049>

### HIDDEN POTENTIALS

During conventional well production lifecycle only 25% to 35% of oil is usually extracted from each well. It is well known, that the most of oil field sedimentary rocks has closed pores filled with oil and practically unattainable by conventional methods. The untapped oil volume is estimated to be from 65% to 75% of known deposits. Thus, there are estimated many billions of barrels of oil still waiting to be recovered.

This staggering amount of remaining oil can be one of America's best hopes for greater energy security and prosperity. Recovering oil from stripper wells have additional financial and exploration benefits. By contrast to new wells drilling, stripper wells are already existing, have proven production histories, production equipment and transportation facilities in place: all known as an infrastructure. It would be great to exploit these wells capability now while spending smaller amount of an investments money.

### EOR WAYS

Another ways to use EOR is to develop newer technologies. Some large oil companies, such as British Petroleum (BP), are trying to experiment with a conventional oil wells recovery by using horizontal drilling and fracking which was developed and successfully used in shale gas and oil explorations.

A latest example is an attempt made by BP to use fracking with horizontal drilling is given in the WSJ September 2 2016 publication “Too Big to Frack? Oil Giants Try Again to Master Technology That Revolutionized Drilling”. Another example of this technology was introduced by Mitchell Energy & Development (now Devon Energy) Co. and is now used by Chief Oil & Gas Co.



### RECOVERY METHODS

To recover oil from the conventional oil deposits the oil industry is heavily investing in a secondary and tertiary oil recovery known as Enhance Oil Recovery (EOR). The EOR is an implementation of various techniques for increasing crude oil production from an oilfield. It mostly consists of methods which inject materials and elements not normally present in the oil reservoir.

There are four primary EOR traditional techniques:

- water flooding
- gas injection
- thermal injection
- chemical injection

Gas injection, which uses gases such as natural gas, nitrogen, or carbon dioxide (CO<sub>2</sub>) accounts for nearly 60% of EOR investments in the United States. Currently, the above mentioned EOR methods are not able to provide a sustainable increase in oil extraction to rescue the oil industry and secure its financial stability.

The horizontal drilling and fracking is a complex and costly process in the shale application and it will arguably benefit conventional well recovery. Besides, while being somewhat affordable for big companies and institutional investors which have all needed resources, for thousands midsize and small companies this technology will not be easily affordable, at least in a near future.

One marketing company “Oil Well Consulting” in a recent article describes the current state of the oil and gas market as follows:

With oil prices fluctuating recently from \$ 40 to \$ 50 per barrel, the oil and gas industry remains in a dire situation. More than 385,000 energy jobs were lost during this downturn. A list of companies filed for bankruptcy or on a verge of the bankruptcy is staggering.

The sharp drop in the oil prices practically stopped oil exploration using fracking technology and horizontal drilling. Investors are shifting attention from shale drilling which became economically prohibitive to conventional oil fields. As it was described by “The Wall Street Journal” (WSJ) article “Land Buyers Stampede in to Texas Oil Patch” in its September 3 2016 issue - Texas Permian Basin is just one example.

The “Big” investors are buying oil fields in other oil rich states across the US in anticipation to capitalize on cost drop of oil lands and wells and in emergence of new technologies.

There are 440,000 depleted (stripper) oil wells in the US. Over 2 million wells are already abandoned or approaching abandonment. Twenty-eight (28) states have stripper oil wells, such as Texas, Louisiana, Oklahoma, Kansas Ohio and others. Texas alone has slightly over 126,000 stripper oil wells.



## GEO-MECHANICAL PHENOMENA

The EOR inability to produce desirable results lies in two geo-mechanical phenomena of conventional oil and gas exploration:

- There are tangential stress conditions that occur in any well after drilling due to rock pressure created by a weight of the overlying rocks: they create annular zone with compressive stresses near wellbore, thus collapsing rock's permeability and restricting access to the prospected hydrocarbons.
- A well completion by use a cumulative perforation in the hydrocarbon layer not relieve the compressive stress zone and has shortcomings like: creating a small passages to the hydrocarbon layer, damaging the cement sheath, debris and colmatation.

Newly drilled well already has a negative potential, which does not disappear in the subsequent opening of the casing (column) and productive formations:

- reduction in permeability
- reduction of porosity
- as a consequence: reduced productivity inflow into the well

This reality has been virtually ignored in the US geo-physical academia and oil industry.

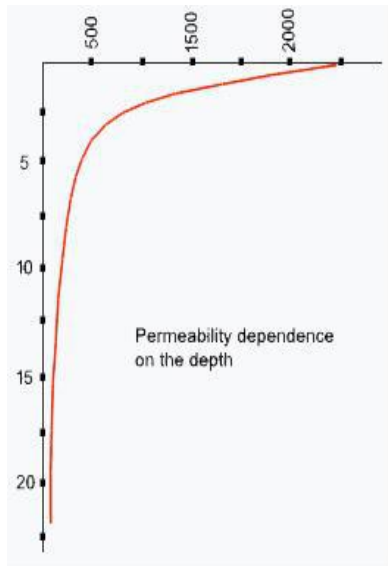
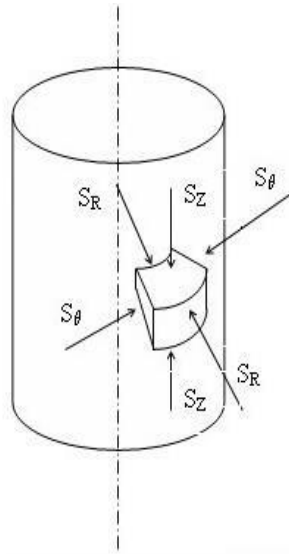

Fig.1 Permeability dependence on the depth



## UNLOADING STRESS CONDITIONS IN THE NEAR WELLBORE ZONE

Technologies of unloading stress conditions in the near wellbore zone exist a long time already, well proven and successfully used in different countries around the world.

It is cutting deep and continuous slots along the wellbore through the casing, cement, and further into the productive formation. In this case, there is a redistribution of stress conditions around the wellbore at the ends of the slots.

As a result:

- Unloading an annular compressive stress conditions in the near wellbore zone occurs up to **50-100 %**
- accordingly increases the permeability up to **30-50 %**
- accordingly increases a useful productive inflow in **5-10 times**

It is Hydro-slotting perforation (HSP) and Hydro-mechanical slotting perforation (HMSP) Technologies. This Project is considering well's re-completion with "classical" Hydro-slotting Perforation Technology.

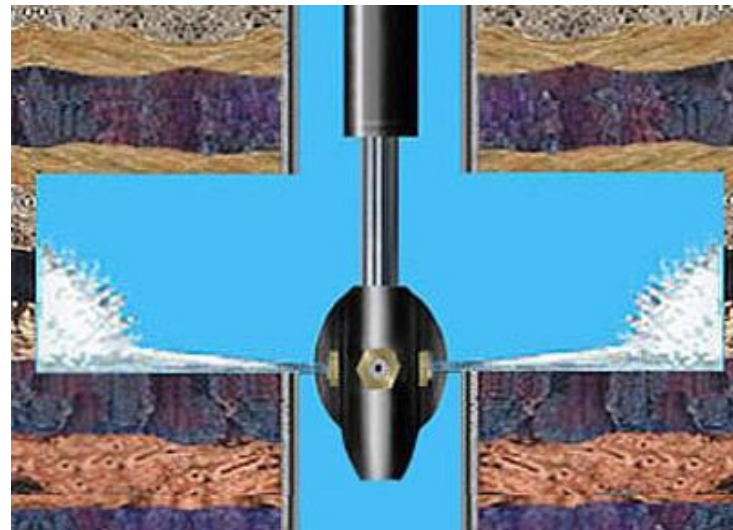

| depth (ft.) | hydrostatic pressure (psi) | effective pressure in the layer (psi) | rock pressure (psi) | compressive stresses around wellbore | unloading stresses in slotting zone after HSP (psi) |
|-------------|----------------------------|---------------------------------------|---------------------|--------------------------------------|---|
| 500 ft.     | 200 psi                    | 270 psi                               | 550 psi             | 895 psi                              | 330 psi - 350 psi                                   |
| 1000 ft.    | 450 psi                    | 540 psi                               | 1100 psi            | 1790 psi                             | 650 psi - 700 psi                                   |
| 1500 ft.    | 700 psi                    | 810 psi                               | 1700 psi            | 2680 psi                             | 980 psi - 1050 psi                                  |
| 2000 ft.    | 900 psi                    | 1080 psi                              | 2250 psi            | 3580 psi                             | 1300 psi - 1400 psi                                 |
| 2500 ft.    | 1100 psi                   | 1350 psi                              | 2800 psi            | 4470 psi                             | 1620 psi - 1760 psi                                 |
| 3000 ft.    | 1350 psi                   | 1620 psi                              | 3350 psi            | 5370 psi                             | 1950 psi - 2100 psi                                 |
| 3500 ft.    | 1550 psi                   | 1890 psi                              | 3950 psi            | 6260 psi                             | 2270 psi - 2470 psi                                 |
| 4000 ft.    | 1800 psi                   | 2160 psi                              | 4500 psi            | 7160 psi                             | 2600 psi - 2810 psi                                 |
| 4500 ft.    | 2000 psi                   | 2430 psi                              | 5000 psi            | 8050 psi                             | 2920 psi - 3160 psi                                 |
| 5000 ft.    | 2250 psi                   | 2700 psi                              | 5600 psi            | 8950 psi                             | 3240 psi - 3510 psi                                 |
| 5500 ft.    | 2470 psi                   | 2970 psi                              | 6160 psi            | 9845 psi                             | 3570 psi - 3860 psi                                 |
| 6000 ft.    | 2700 psi                   | 3240 psi                              | 6720 psi            | 10740 psi                            | 3890 psi - 4210 psi                                 |
| 6500 ft.    | 2920 psi                   | 3510 psi                              | 7280 psi            | 11630 psi                            | 4210 psi - 4560 psi                                 |
| 7000 ft.    | 3150 psi                   | 3780 psi                              | 7840 psi            | 12530 psi                            | 4540 psi - 4920 psi                                 |
| 7500 ft.    | 3370 psi                   | 4050 psi                              | 8400 psi            | 13420 psi                            | 4860 psi - 5270 psi                                 |
| 8000 ft.    | 3600 psi                   | 4320 psi                              | 8960 psi            | 14320 psi                            | 5180 psi - 5620 psi                                 |
| 8500 ft.    | 3820 psi                   | 4590 psi                              | 9520 psi            | 15210 psi                            | 5510 psi - 5970 psi                                 |
| 9000 ft.    | 4050 psi                   | 4860 psi                              | 10080 psi           | 16110 psi                            | 5830 psi - 6320 psi                                 |
| 9500 ft.    | 4270 psi                   | 5130 psi                              | 10640 psi           | 17000 psi                            | 6160 psi - 6670 psi                                 |
| 10000 ft.   | 4500 psi                   | 5400 psi                              | 11200 psi           | 17900 psi                            | 6480 psi - 7020 psi                                 |

Hydro-slotting perforation (HSP) Technology may apply in

- oil, gas, injection, and hydro-geological wells
- vertical and horizontal wells
- newly drilled and old wells
- sandstone, carbonate, shale, thinly interbedded, etc. formations
- shallow and deep wells
- high-temperature and low-temperature wells
- low-viscosity and high-viscosity, etc.

Hydro-slotting perforation (HSP) Technology refers to the main methods of initial opening the productive formation, and is used as an independent method, as well as (if necessary) in combination with subsequent stimulations, chemical treatments, hydraulic fracturing's, etc.

From practice HSP increases productive inflow in low productive, dry, dead wells from 0-1 bbl./day up to 30-50-70 bbl./day with lasting effect up to 10 years and more.

more information: [www.maxxwell.us](http://www.maxxwell.us), [www.maxxwell.ca](http://www.maxxwell.ca), [www.maxxwell.net](http://www.maxxwell.net)

# HYDRO-SLOTTING PERFORATION TECHNOLOGY

- Hydro-slotting perforation technology is the cutting of continuous slots (“windows”) along the wellbore.
- The main idea of the technology is unloading of the annular compressive stress conditions (stress-strain states) around the wellbore zone.
- Hydro-slotting perforation refers to the basic methods of opening the casing, cement and productive formation.

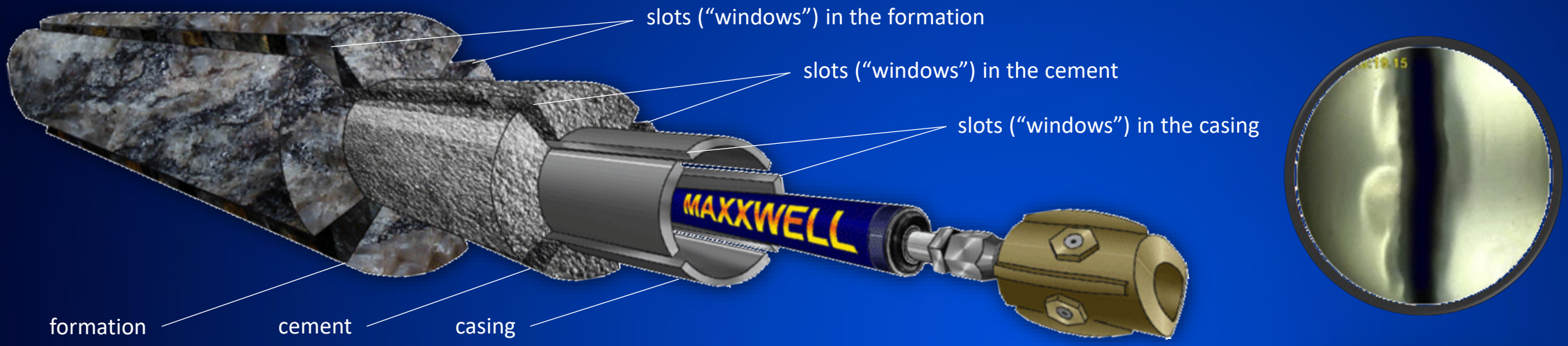

|   |  |
|---|--|
| ecologically safe, environmentally friendly (produced water and an abrasive filler)                                       | Accordingly the increase in the useful inflow up to <b>5-10 times</b>                              |
| penetration depth is up to <b>1.5 m (5 feet)</b>  | can be used in oil, gas, and injection wells   |
| opening area per one linear meter is up to <b>6 m<sup>2</sup> (2 nozzles)</b> , and <b>12 m<sup>2</sup> (4 nozzles)</b>   | can be used in newly drilled and low productivity, low debit wells                                 |
| opening area per one linear foot is up to <b>20 ft<sup>2</sup> (2 nozzles)</b> , and <b>40 ft<sup>2</sup> (4 nozzles)</b> | can be used in vertical and horizontal wells, with tubing and coiled tubing                        |
| cutting speed is one linear foot per <b>60 min</b> (cased wells) and one linear foot per <b>30 min</b> (open hole)        | can be used in any formation (sandstone, carbonates, shale's, thinly interbedded, quicksand, etc.) |
| simultaneous cutting <b>2, 3, and 4 slots</b> along the wellbore  | can be used near the water reservoirs (impossible to make a hydraulic fracturing)                  |
| no detonation impact, no casing damage, no cement cracks, no clog-up the formation borders                                | extract more than <b>20 %</b> of additional oil from the layers with higher productivity           |
| unloading of the annular compressive stress conditions in the near wellbore zone up to <b>50-100 %</b>                    | duration of the effect over <b>10 years</b>  |
| Accordingly the increase of permeability up to <b>30-50 %</b>   | make an excellent geometry for subsequent fracturing (if necessary)                                |

- The efficiency and duration of effect of all additional stimulation's methods depends on the size (area) of opening the casing, cement and productive formation.

# ANNUAL COMPRESSIVE STRESS CONDITIONS

It is known that during the drilling in any well (any perforation hole) in and around the wellbore annular (tangential) compressive stress conditions (stress strain states) are created. The deeper the well, the more compressive stress conditions. Under this action and high overburden pressure occurs a significant reduction of permeability in the near wellbore zone, and in some cases close to near zero. Oil or gas flow can not penetrate to the well.

Deterioration of the rock's permeability in the near-wellbore directly from the borehole wall is one of the main causes of the declining production rate of oil and gas wells. This occurs both during drilling and during their operation (figure on the left).

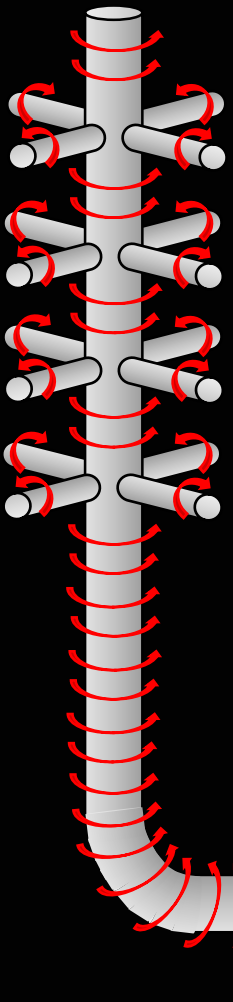

Any cumulative or perforation holes only create the additional annular compressive stress conditions around it, and which further deteriorates the collector properties of the productive formation, deteriorate permeability and consequently still reduces the production rate of oil and gas wells.

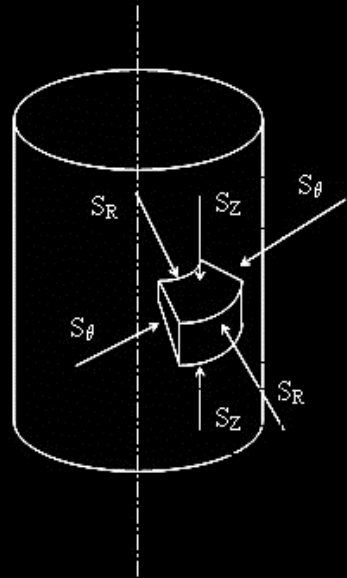

$S_R$  - radial stress  
 $S_e$  - tangential stress  
 $S_z$  - vertical stress

On the rocks lying at depths of 3–5 km the compressive stresses may reach up to 75–125 MPa. In the near wellbore zone, as a result of concentration these stresses increase and sometimes become equal to or double 150–250 MPa. If the tectonic stress is several times higher than stress from the weight of rocks, the stress in the near-well zone may be even greater.

How is it possible to offload the rocks from its existing shear stresses ?

How to unload annular compressive stress conditions in the near wellbore zone and thereby improve the permeability and accordingly increase the production rate of oil and gas wells ?

The idea came from the coal industry (coal mines). Since ancient times, when there were the first coal mines, it was observed, that increasing the depth of the development the coal tunnel, under the action of overburden pressure, surrounding rocks become harder and little-permeable. To solve this problem they developed a cavern of a certain form in the rock.

The only possible solution in this situation, in relation to oil and gas wells, is to offload the rocks from its existing shear stress. In particular, the current decrease in near wellbore zone, the hoop stress.

In practice, this can be achieved by cutting continuous slots ("windows") in the vertical section of the wellbore.

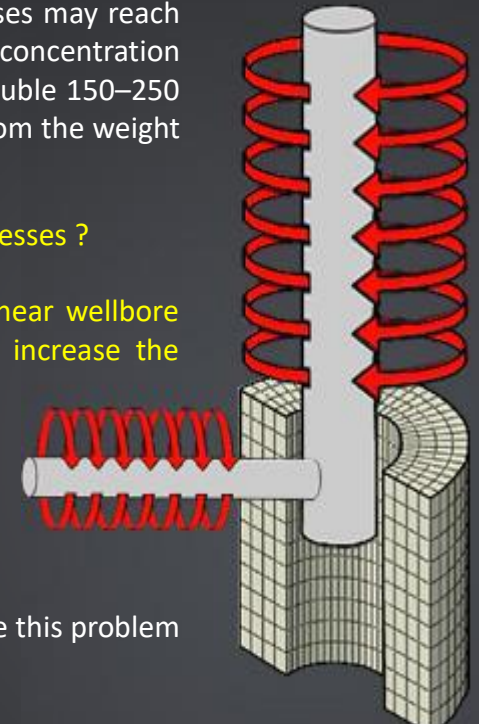

# CONTINUOUS SLOTS ("WINDOWS") ALONG THE WELLBORE

The first figure below shows that the borehole is surrounded by low permeable "cork" thickness which is approximately 50 % of the well's radius. From figures 2 and 3 shows that two or four diametrically opposite vertical continuous slots is almost twice lower operating on the circuit hole shear stresses, and reduced permeability areas are significantly reduced in size and are pushed into the interior of the reservoir. Thus, the presence of vertical slots significantly improves the situation, and generally retains rock permeability.

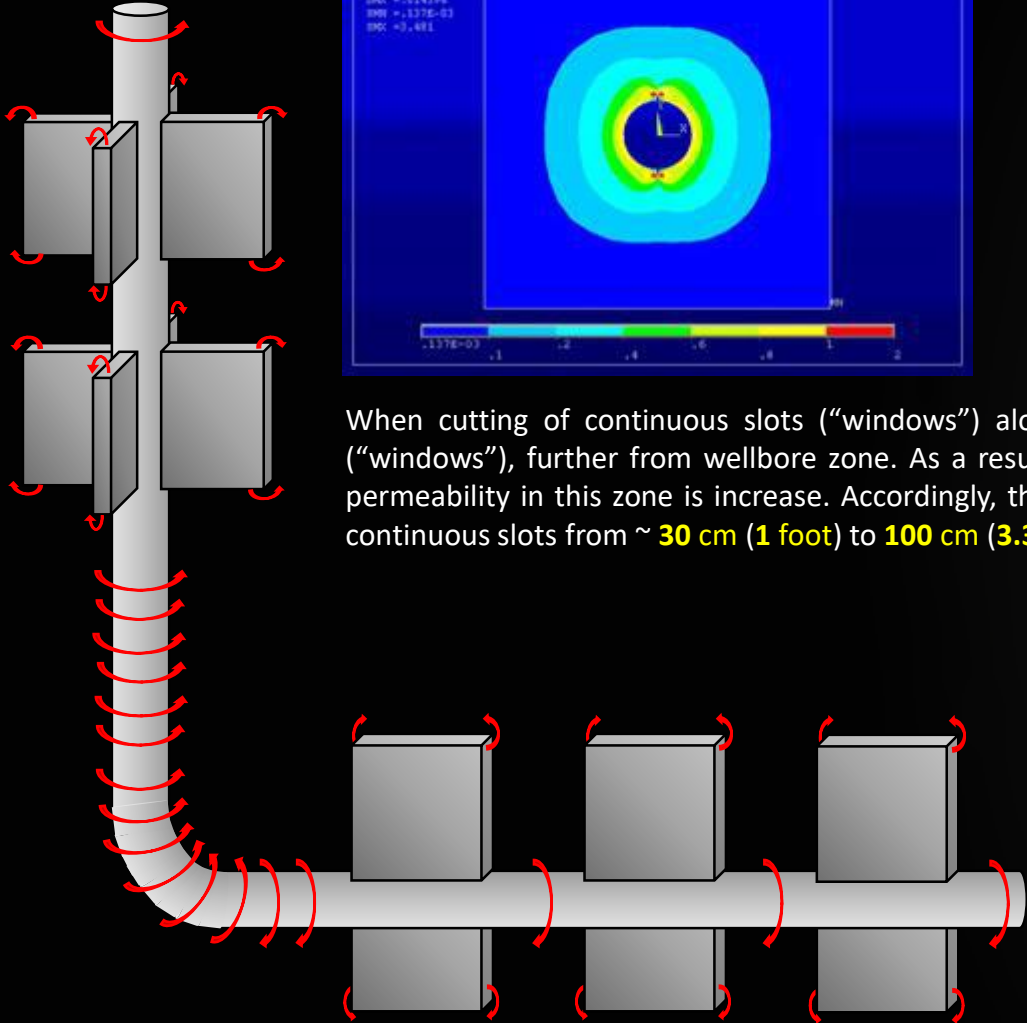
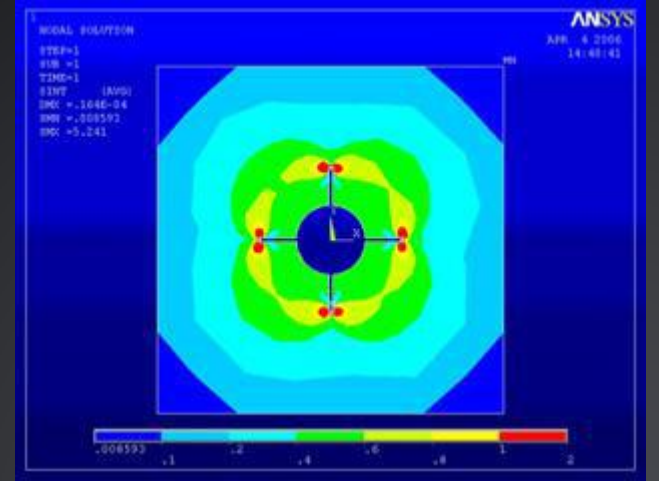
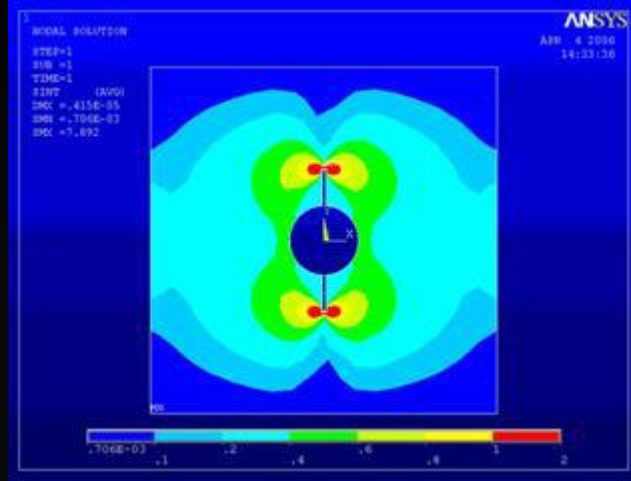
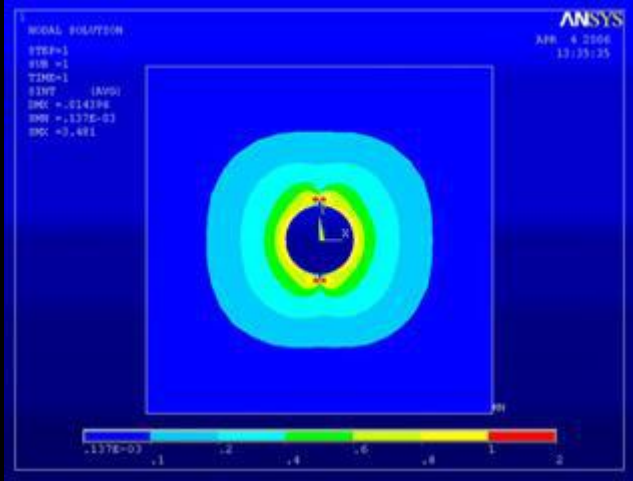

When cutting of continuous slots ("windows") along the wellbore occurs the redistribution of the annular stress conditions to the ends of these slots ("windows"), further from wellbore zone. As a result, the stress in the near wellbore zone is reduced. Occurs the unloading of stress state. Accordingly, the permeability in this zone is increase. Accordingly, the productive inflow to the well also is increase. The effect of stress state's discharge occurs at a depth of continuous slots from ~ 30 cm (1 foot) to 100 cm (3.3 feet).

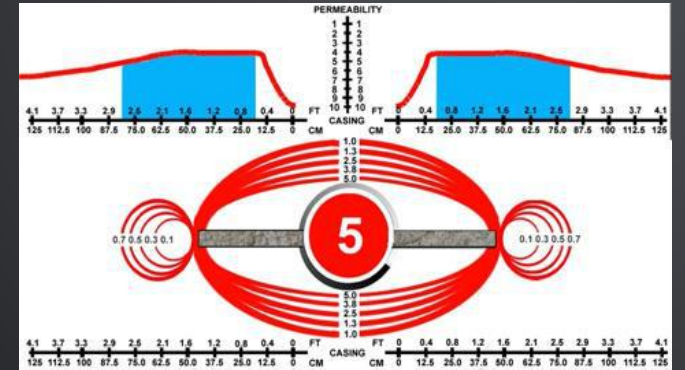
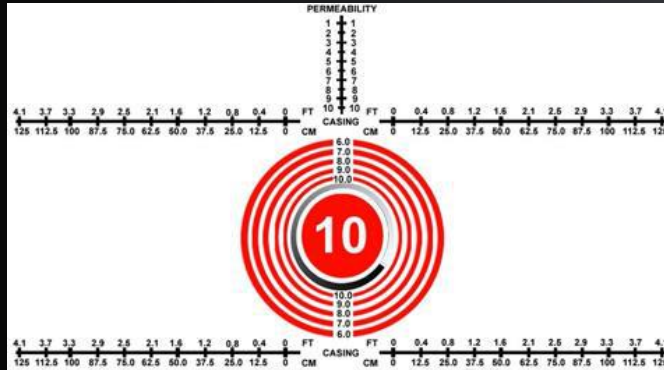

How to cut a continuous deep slot along the wellbore section through the casing, cement and further into the productive formation ?



# HOW TO CUT CONTINUOUS SLOTS (“WINDOWS”) ALONG THE WELLBORE

How to cut a continuous deep slot along the wellbore section through the casing, cement and further into the productive formation ?

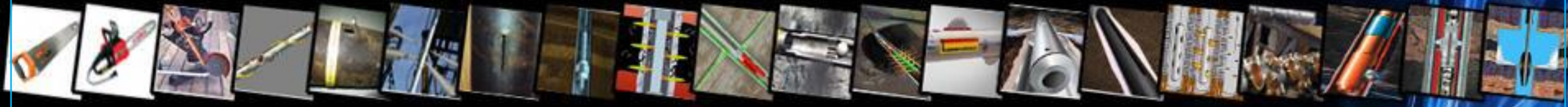

## MINING GEO-MECHANIC’S REQUIREMENTS

- Large opening area of a casing, cement ring and productive formation - it provides a good hydro-dynamic connection between productive layer and the well.
- The depth of penetration into the productive formation - it provides the unloading the stress conditions in the near wellbore zone and accordingly increases the permeability.
- Preventing the formation of crusts on the border of opening zone - this prevents the inflow of useful product and requires additional actions.
- Preventing cracked of cement ring - it provokes the flows of water and increases the risk of well's flooding.

All currently known main methods of opening the casing, cement sheath and productive formation (mechanical and jet, shock-explosive and sparing, stressed and unstressed, etc.) have their own drawbacks :

- detonation impact • casing damage • cement crack • borders clog-up • formation damage • uncontrolled direction • affects the other layers and zones • low efficiency • unwanted flows generating • short duration effect • shallow penetration depth • increase of annular stress conditions in the near wellbore zone • permeability decreasing • well life’s reducing •

None of these methods does not create the real continuous, geometrically correct and deep slots (“windows”) along the wellbore, and correspondingly does not discharged stress-strain states in the near wellbore zone. Opening area of casing in all cases is small enough.

- In additional the efficacy and duration of effect of all currently known additional stimulation’s methods (as acoustic, cavitation, chemical treatment, electric, frequency, impact, impulse, laser, magnetic, oscillations, plasma, pneumatic, temperature, ultrasound, vacuum, vibrations, voltage, warming-up, wave, etc.) is directly depends on the size (area) of opening the casing, cement and productive formation.

## DIMENSION’S COMPARISON OF DIFFERENT OPENING’S METHODS

| gun perforation  | jet perforation  | shooting perforation  | abrasive perforation  | mechanical hydro-slotting perforation  |
|--|--|---|---|--|
| Depth inches 5.9<br>Depth foot 0.5<br>Drainage (Penetration):<br>Square inches 18.0<br>Square foot 0.15<br>Negative:<br>Detonation impact<br>Crack casing<br>Crack cement<br>Clog-up the borders | Depth inches 5.9<br>Depth foot 0.5<br>Drainage (Penetration):<br>Square inches 18.0<br>Square foot 0.15<br>Negative:<br>Detonation impact<br>Crack casing<br>Crack cement<br>Clog-up the borders | Depth inches 4.72<br>Depth foot 0.39<br>Drainage (Penetration):<br>Square inches 0.53<br>Square foot 0.004<br>Negative:<br>Detonation impact<br>Crack casing<br>Crack cement<br>Clog-up the borders | Depth inches 7.87<br>Depth foot 0.85<br>Drainage (Penetration):<br>Square inches 15.0<br>Square foot 0.13<br>Negative:<br>Detonation impact | Depth inches 16.0<br>Depth foot 1.3<br>Drainage (Penetration):<br>Square inches<br>Square foot<br>Negative:<br>The depth of the slots is limited<br>The movement from the tubing |

## ABRASIVE JET (HYDRO-JETTING) PERFORATION

Slots along the wellbore is possible to cut using abrasive jet perforation or mechanically. But in mechanical methods (circular saw, for example) it is impossible to use abrasive filler, we will not get the deep slots. Consider in more detail an abrasive jet perforation (or **point jet perforation**).

Abrasive jet (hydro-jetting) perforation relates to the main methods of opening the casing, cement sheath and productive formation. AJP is widely used in oil and gas industry as a main opening method, and an auxiliary, for subsequent hydraulic fracture.

Abrasive jet perforation does not damage the casing, not crack the cement sheath, and not damage the formation. This is environmentally friendly method (produced water and an abrasive filler). Point jet perforation does not unload the annular compressive stress conditions in the near wellbore zone (profile is the hole  $D=2.5\text{ cm}$  (**1 inch**) and  $L=30\text{ cm}$  (**1 foot**)), and it regardless of the number of holes.

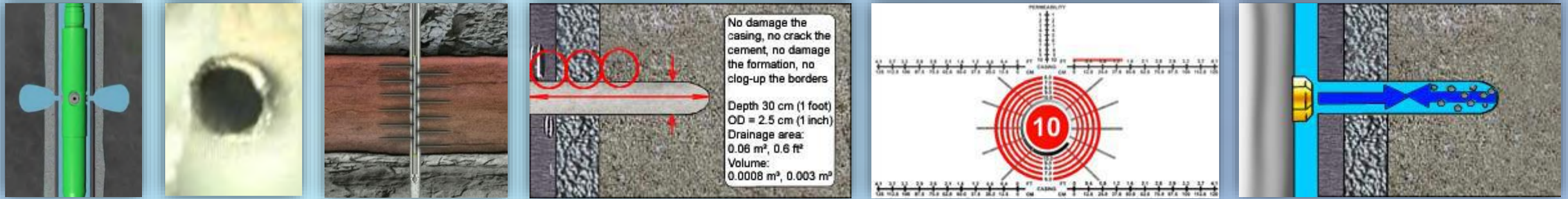

- The depth of holes does not depend on time application and not becomes deeper. This happens because the reverse jets from the holes hinder direct jets from the nozzles, and perforated rock can not freely go out from the holes (excavation effect does not occur).

Increasing the number of nozzles does not create continuous slots too, and only creates additional annular stressful conditions around the perforation holes.

- To create the continuous and deep slots needed, the interference must be prevented by eliminating the streams from competing. A free exit of perforated rock from the holes must be created, and this is accomplished through **MOVING** the jets (nozzles) continuously along the wellbore. But such a move is impossible to get by moving the tubing or coiled tubing from the surface. Both tubing and coil tubing have their own frequency and stretch. The working jets will jump (figures on the right) causing a scissor cut. In the best case, a cavern will be formed. The movement of cutting jets (nozzles) shall be applied directly at the cutting place (cutting interval) within the borehole and not depend on the movement of the tubing or coiled tubing.

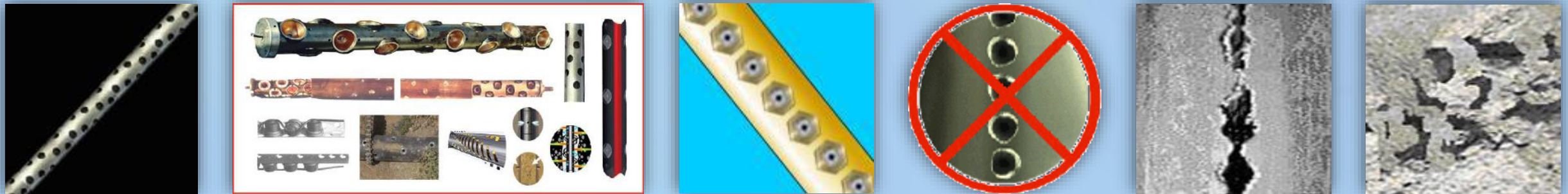

# CONTINUOUS MOVING JET (HYDRO-JETTING) PERFORATION

- The movement of cutting jets (nozzles) shall be applied directly at the cutting place (cutting interval) within the borehole and not depend on the movement of the tubing or coiled tubing.

The movement of cutting jets (nozzles) shall be constant and rectilinear, with a speed, enough for cutting casing, cement and deeper into the productive formation. Working jets (nozzles) all the time are moving to lower from the formed holes, reverse jets from the holes do not interfere direct jets from the nozzles, and perforated rock freely go out from the holes to the surface, together with the flow of fluid. The slots in the formation becomes deeper and deeper. Any angles of the nozzles are not necessary.

In this case along the wellbore it will be formed continuous and depth slots, with a good enough geometry. Accordingly, will occur unloading of annular stress conditions in the near wellbore zone, and consequently permeability in this area will be increased, which will lead to an increase in the productive flow to the wellbore.

- Such a movement can be created by a special device with electrical, mechanical or hydraulic / pneumatic principle.

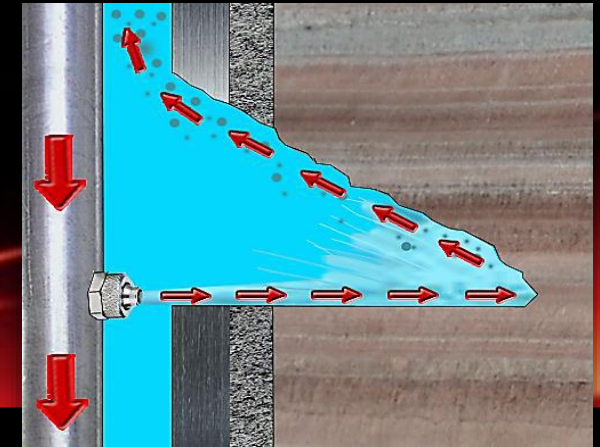

## HYDRAULIC SLOT-PERFORATION TOOL



- Hydraulic slot-perforation tool is not only iron. This is research, design, tests and mistakes, manufacture and tests again, continuous improvements and creating of new models. This is geological analysis and determination of the most promising cutting intervals, calculation of the technological parameters for slotting perforation process and "cut program" instructions. This is special computer programs, skills and knowledge, operational experience and "know-how". Finally, it is the intellectual property.

# HYDRAULIC SLOT-PERFORATION TOOL - IT IS VERY EASY

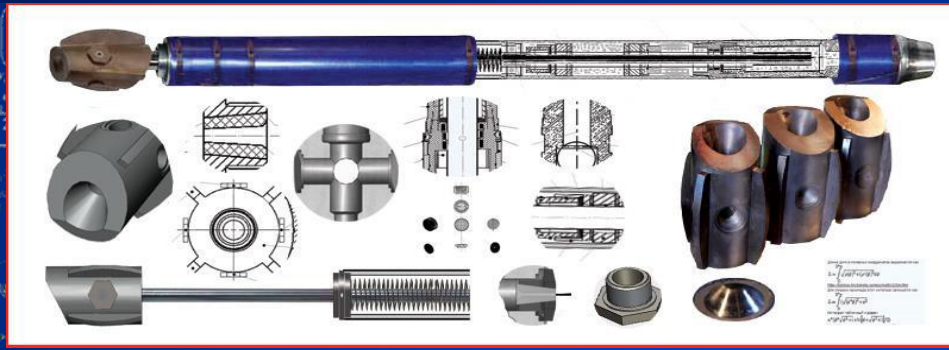
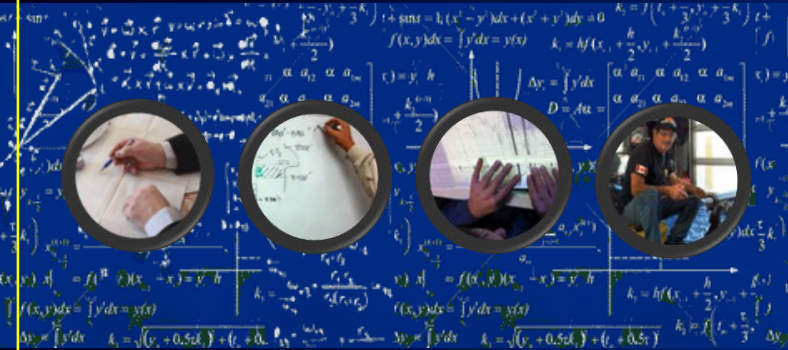

The principle of operation are the following. When applying working fluid (produced water and an abrasive filler) pressure, the working rod with perforator starts to make rectilinear motion with constant slow velocity. Jets (2, 3, or 4) of working fluid with abrasive filler start cutting the casing (if the well is cased), cement and further into the productive formation. Since the perforator with working nozzles are constantly moving, forward and reverse jets (from the formed slots) they do not interfere with each other, cut (slot) becomes deeper and deeper, spent abrasive filler and rock freely escapes with the stream of working fluid to the surface. At the stop pressure supply operating rod with perforator is set up to the starting (initial) position, and the tool can be moved to the next cutting interval. Thus it is possible to cut the long continuous slots, or via specified interstices.

## PATENT US 8863823



Patent **US 8863823** from October **21, 2014** is the latest invention of hydraulic slot-perforation tool "Universal underground hydro-slotting perforation system, controlled by working fluid pressure, for activation and intensification of gas, oil and hydro-geological wells". This patent includes design and operation of ① hydraulic unit (slotting perforation engine), ② return unit (spring block), ③ perforator, ④ nozzles, nozzle-holders and ⑤ adapter.



① **Hydraulic unit** (slotting perforation engine), it is a main part of the tool for performing of slotting perforation process. This unit provides the constant rectilinear motion of the working rod with the perforator and working nozzles at a certain speed (speed determines the depth of cut), depending on the operating pressure and temperature of the working fluid. The unit is sealed and autonomous. The valve and the floating pistons provides a change of internal volume, depending on the hydrostatic pressure. The flow controller sets a constant speed of the working rod, depending on temperature and pressure of the working fluid (produced water and an abrasive filler).



2

**2 Return unit** (spring block), it is a part of the slotting perforation tool. This unit provides return of the operating rod of hydraulic slotting perforation engine into the initial (start-up) position after stop supply the pressure at the end of the next cutting interval. The block becomes sealed when the pressure supply. Exists spring blocks of direct action (direct slots) and spiral action (spiral slots for use in the case with two nozzles in the perforator, and when the direction of the highest fracturing of the deposit-field is unknown). It consists of housing, rod, springs, regulating devices, airtight lids and seals.



6

**6 Compensators** using for stimulation of the slotting perforation process in vertical oil, gas, injection or hydro-geological wells (open/cased). Compensators can work with regular tubing only.



3

**3 Perforators** it is an integral part of any slotting perforation process (hydro-slotting, jet slotting, or jet point perforation). Perforator it is the unit of turbulent' s zone, where the working fluid it changes the directory of movement from the working rod direction into the cutting's nozzles. Requirements for perforators: long period of operation (made from one piece of solid metal), ergonomics (low pressure loss), streamlined shape (not scratch the casing), the ability to direct and back flushing even when lowering the tool on the ground. There are many types of perforators varying according to design, type, form, destination, number of nozzles and stiffened ribs, for different type of wells, diameter, tasks, etc. Exist ergonomic, streamlined, multiple use, for vertical and horizontal wells, self-oriented, swiveling, etc.



3

**4 Nozzles** for perforators are made from high quality tungsten mixture of carbide, tungsten, corundum, technical diamond grit and special additives in a definite proportion. Nozzles must to meet all the technological process requirements of the slot perforation process: lasting of work, resistance to high temperature, high pressure, impacts, crumbling and have a hardness of more quartz. Nozzles have a different design and size depending on the shape of the nozzle-holders and perforators, where they are used.



4

**5 Adapters** it is a connecting elements between tubing or coiled tubing and slotting perforation tool. Adapters also can perform other important functions, for example, saddle for a valve ball for testing of tubing or coiled tubing may be located in the shank of slotting perforation tool, or within adapter. Adapters are made from special nonmagnetic material, that is visible in the emissions of radioactive logging during the correlation and installation of the first cutting interval. In this case, adapter also serves as a **marker**. Exists elongated adapters, smoothing fluctuations of the supply pressure of the working fluid. In this case the adapter partially function as compensator.



5

## SECURITY AND SAFETY OF THE TOOL

- This equipment is environmentally safe (using produced water and an abrasive filler)
- This equipment is not used any hazards materials (chemical, thermal, radiological, etc.)
- Hydraulic unit is a closed sealed self-regulating system for prevent explosion under the action of hydrostatic pressure in a water-filled borehole.
- Perforator is designed so stiffness ribs did not scratch the casing.
- Perforator does not burrow into the sand completely.
- If accidentally lowering the tool on the ground remained the possibility of reverse (and direct) flushing.
- Almost all threaded connections involve the use of Teflon (oil) tape.
- Rod with the perforator starts to move at a pressure **800 psi (5.5 Mpa)**.
- Maximum pressure of the hydraulic fluid **6500 psi (45 Mpa)** (taking into account losses in the pipes).
- With further increase in pressure dosing device in the main piston (hydraulic block) snap on, hydraulic oil will flow through the gap between the main piston and the rod, the rod stops moving.
- When the pressure drops below **800 psi (5.5 Mpa)** or pressure is cut (at the end of cutting, e.g.) rod with a working perforator will be immediately recharged (set-up) to the starting (initial) position, and will be ready for use again (on the next cutting interval, for example)
- Spring in the return block no operative in a free state.
- Spring is limited by special washers and nuts on the rod. In addition returning unit is limited by the protective cover from the perforator side.
- If the spring breaks during the slotting perforation process, the rod with perforator still recharged (set-up) to the starting (initial) position.
- If perforator will break (even with a base spring rod) then the spring will not pops out from the return block because it will be hold the bottom with the protective cover.

# HYDRO-SLOTTING PERFORATION PROCESS

Surface equipment for slotting perforation process is absolutely standard as for the jet perforation or hydraulic fracturing, only proppant (sticky sand) is not needed (wide vertical slots does not collapse). Instead abrasive quartz sand is needed .

- rig with crew (or coiled tubing service)
- tubing (or coiled tubing)
- wellhead and surface piping
- tank with formation water
- cutting tank and abrasive filler mixer (shaker, blender)
- frac service (pump service) with monitoring
- high pressure line with Manifold block
- abrasive filler (abrasive quartz sand)

- lowering the tool
- correlation log
- position correction
- tubing pressure test
- reverse flushing
- cutting first interval
- direct flushing
- lifting tool for the next cutting interval
- cutting next interval
- direct flushing
- reverse flushing
- lifting tool
- swabbing water

The tool is connected to the tubing or coiled tubing through the adapter with standard connections and lowered into the well on a predetermined depth of the first cutting interval. Hydraulic camera will set the volume itself, depending on the hydrostatic pressure. Tubing connections can be checked by the pressure with the valve ball in the adapter. After flushing out a test ball from the adapter to the surface, can be make flushing directly through the tool. After lowering through the tubing the service valve ball in the perforator, tool ready for cutting. When working pressure fluid (produced water and an abrasive filler) is supplied, rod with perforator and nozzles starts to make slow down the linear motion with constant velocity, enough for cutting casing, cement and further into the productive formation. The speed and depth of the cutting slots is regulated by pressure, concentration of abrasive filler and temperature of the working fluid. When stop applying pressure the rod with perforator and nozzles returns to the initial (set-up) position. The tool moves to the next cutting interval and the operation is repeated. After flushing out the service valve ball from the perforator to the surface, can be make flushing directly through the tool.

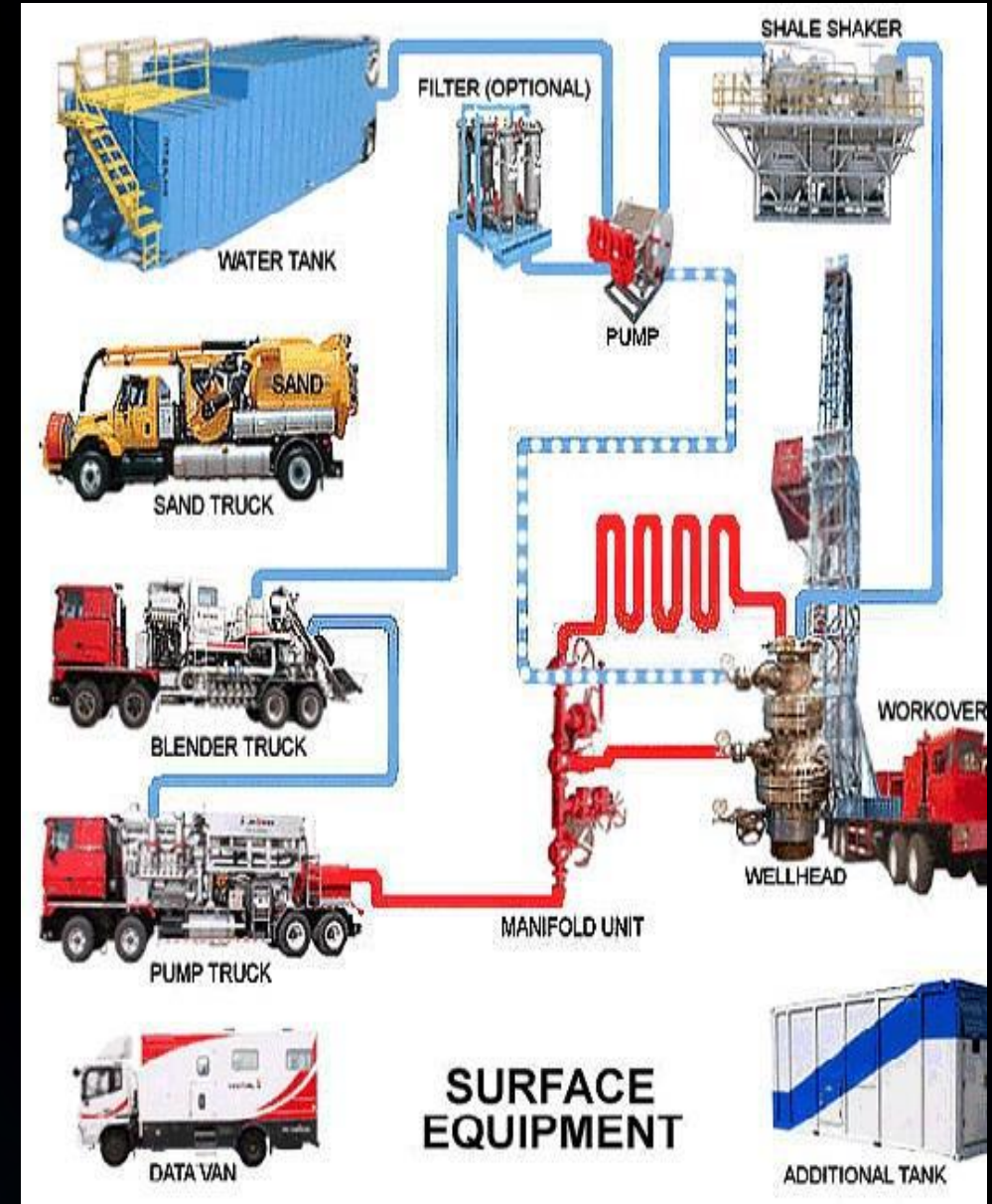
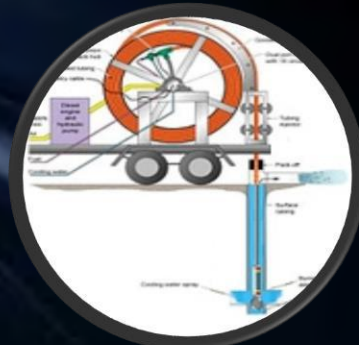

# HYDRO-SLOTTING PERFORATION PROCESS

Some technical parameters of the slotting perforation process. The figure on the left shows a diagram of pressure, slurry rate and abrasive concentration. The figure on the right shows the cutting speed dependence on temperature and pressure (installed in the lab).

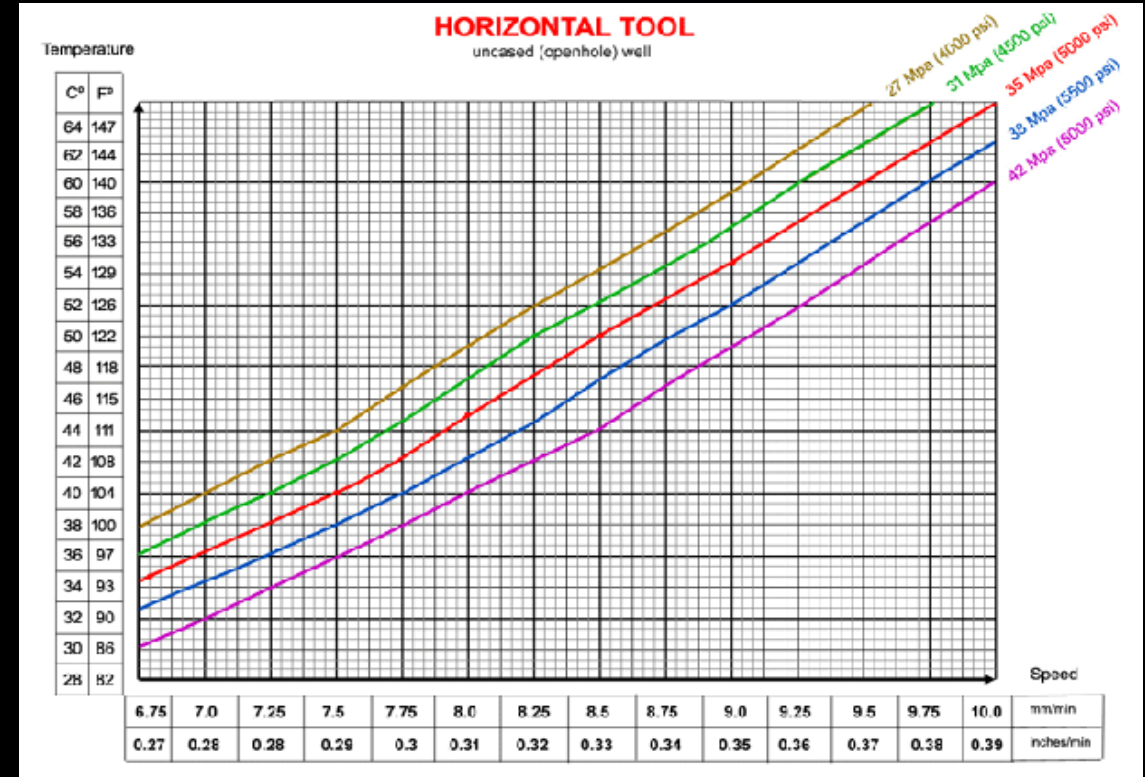
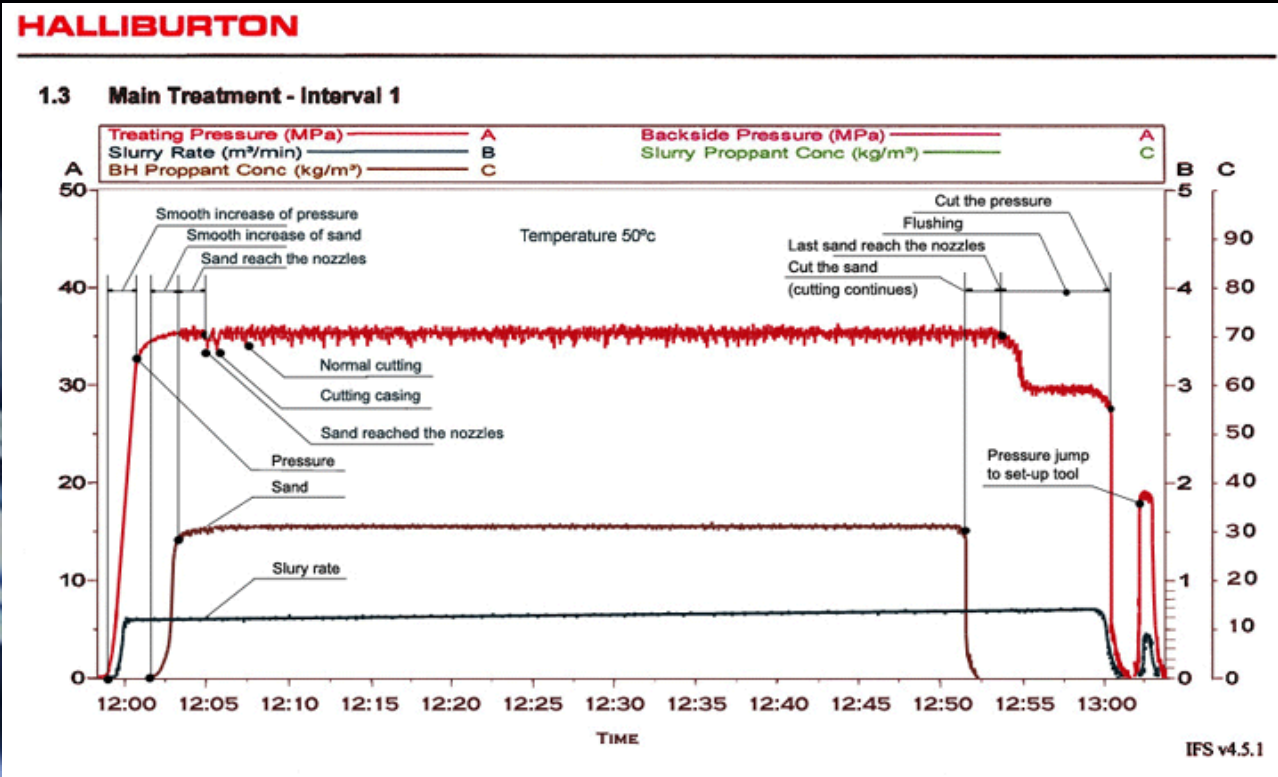

Maximum cutting depth with slotting perforation does not exceed **1.5 meters (or 5 feet)**. Greater depth of cut can not be done in connection with the physical and structural features of nozzles. With increasing pressure, increases only conicity of jets behind the nozzles (increases spraying zone), but increasing the depth of the jets does not occur. For a real increase in the cutting jets it is necessary to extend the body of nozzles, that is impossible to make - the length of the nozzles must be greater than the diameter of the well. Diameter of the tubing or coiled tubing is not

very important, slot-perforation tool is connected to the tubing or coiled tubing through the standard adapters (varying diameters). The size of the tubing can be limited only by design of the internal diameter of the working rod in the slot-perforation tool and is equal to **30 mm (1.2 inches)**. But in such a small diameter, pressure losses in the pipes will be quite large. Therefore, with respect to the diameter of tubing or coiled tubing is possible to say: the more - the better. Pressure increase leads to the simulation of hydraulic fracturing, and an increase in the concentration of an abrasive additive causes early erosion nozzles and

perforator, but does not affect the depth. Much more important design parameter is the internal diameter of casing in vertical wells (or open hole for horizontal wells). Currently the design of slotting perforation equipment allows to operate in the wells with casing OD=**100 mm (4 inches)** for vertical wells, and OD=**120 mm (4.5 inches)** for horizontal wells. In the nearest future it is planned to create slotting perforation equipment for operate in the wells with OD=**75 mm (3 inches)** and OD=**89 mm (3.5 inches)**. Tool orientation in horizontal wells. Currently there is only a self-oriented (self-aligning) perforator for horizontal wells (figure on the right). Perforator can

can create vertical slot in the upper direction or vertical slot in the down direction in the horizontal wellbore.

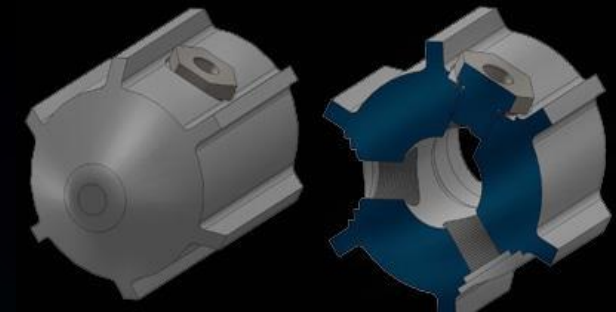

# GEOMETRY OF CUTTING SLOTS (“WINDOWS”)

- Cutting depth is adjustable parameter. Cutting length depends on the length of the working rod. The number of slots depends on the number of nozzles in the perforator.

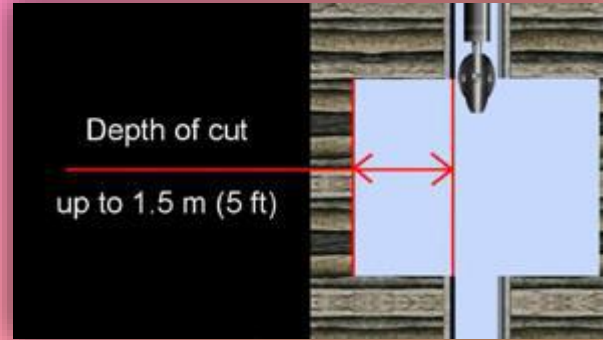
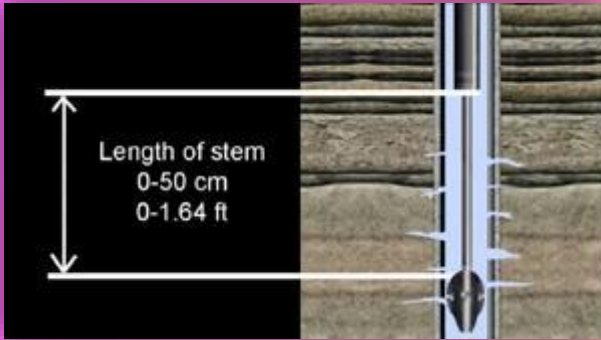

Surface area of one slot (opened with one nozzle = surface area of the left wall + surface area of the right wall + surface area of the top wall + surface area of the bottom wall + surface area of the back wall:

For example, if the length of the rod is 0.5 m (1.64 ft or 19.7 in)

- Slot depth (a) (max) 1.5 m (4.92 ft or 59.1 in)
- Slot length (b) 0.5 m (1.64 ft or 19.7 in)
- Slot width (c) 0.025 m (0.08 ft or 1 in)

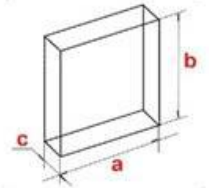

Surface area = (a x b) + (a x b) + (a x c) + (a x c) + (b x c) = 1.59 square meter, or 17.12 square ft, or 2464.5 square in.

| slot length    | 2 nozzles            | 3 nozzles             | 4 nozzles             |
|----------------|----------------------|-----------------------|-----------------------|
| 1 linear meter | 6.2 m <sup>2</sup>   | 9.3 m <sup>2</sup>    | 12.4 m <sup>2</sup>   |
| 1 linear foot  | 21.4 ft <sup>2</sup> | 32.13 ft <sup>2</sup> | 42.84 ft <sup>2</sup> |

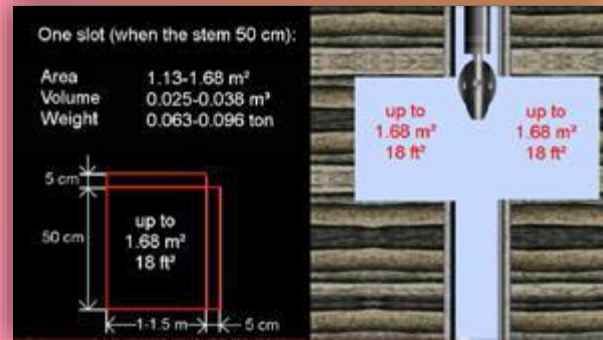
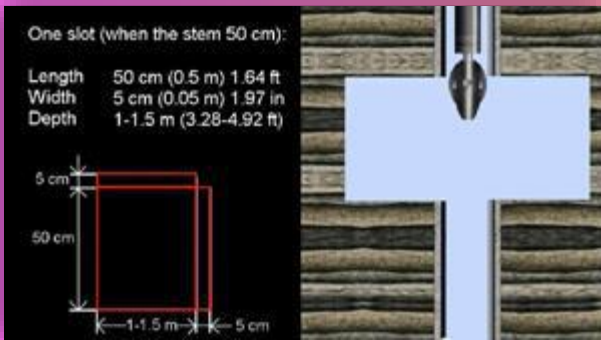

## PROCEDURES COMPATIBLE WITH THE SLOTTING PERFORATION PROCESS

|   |                                 |    |                              |
|---|---------------------------------|----|------------------------------|
| 1 | correlation log                 | 10 | cutting the injection wells  |
| 2 | pressure tubing test            | 11 | bypassing the water layers   |
| 3 | cutting process                 | 12 | bypassing the casing collars |
| 4 | re-cutting process              | 13 | direct flushing              |
| 5 | cutting thin-interbedded layers | 14 | reverse flushing             |
| 6 | cutting the shale               | 15 | chemical treatment           |
| 7 | creating a continuous slot      | 16 | sealant injection            |
| 8 | accurate cutting near the water | 17 | mini hydraulic fracturing    |
| 9 | cutting depth and speed reduced | 18 | few casings cutting          |

## WHAT CAN BE DONE WITH SLOTTING PERFORATION TOOL

thin interbedded layers

shale's

near the water

few casings

mini fracturing

bypass couplings

chemical treatment

direct/reverse flush

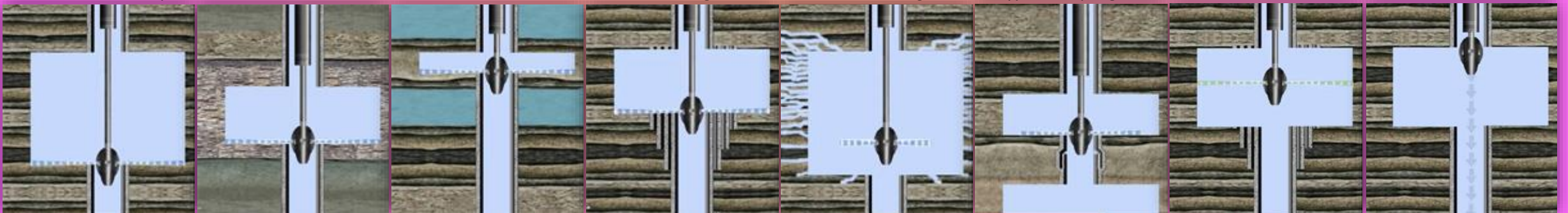



# RESULTS AFTER OPERATION OF HSP TOOL/EQUIPMENT

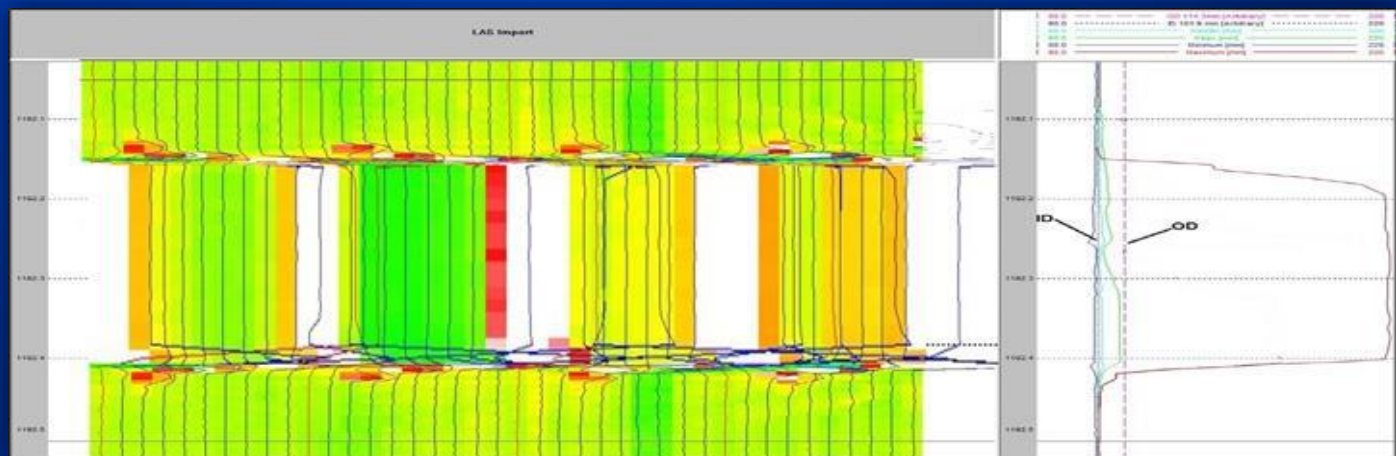
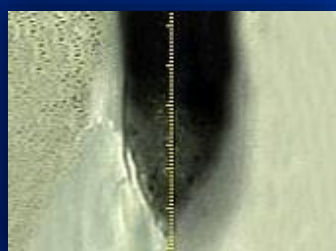
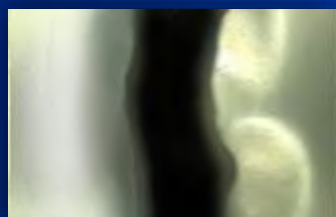
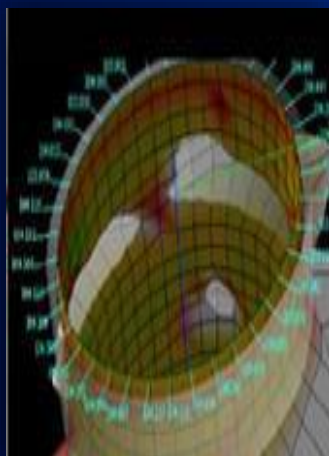
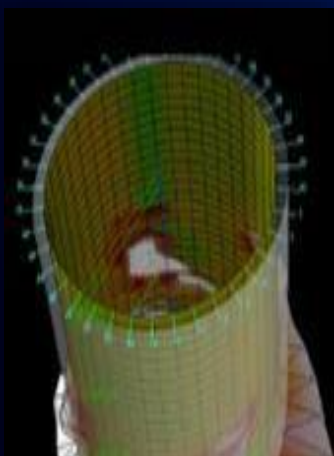
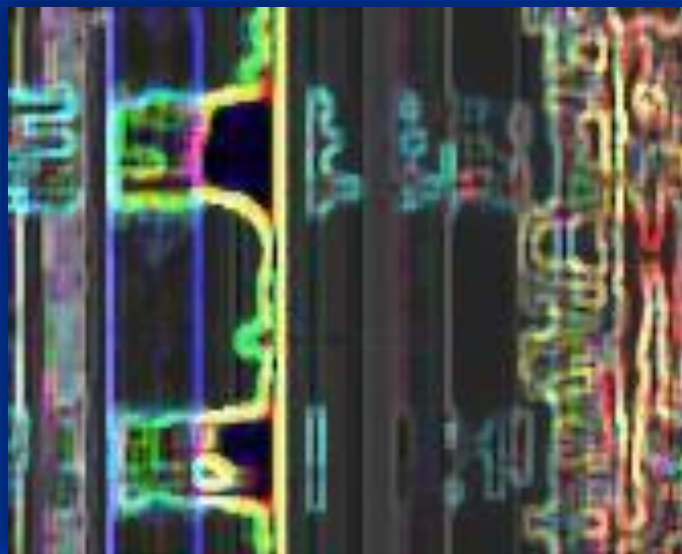
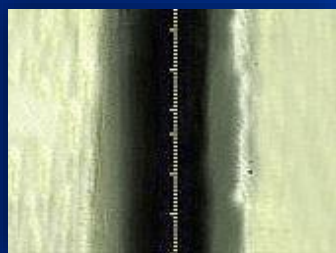
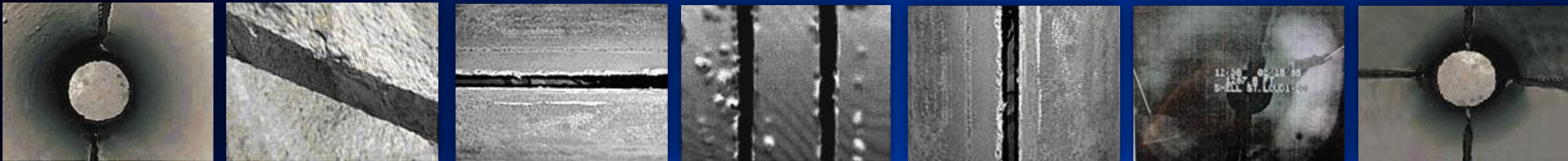

# BENEFITS FROM HYDRO-SLOTTING PERFORATION

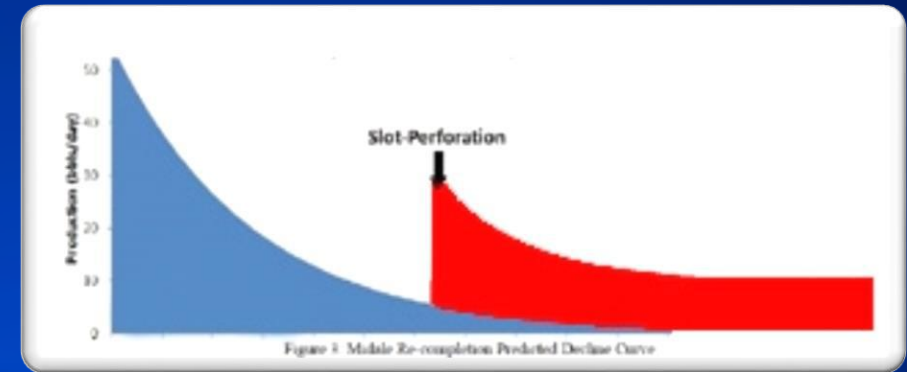
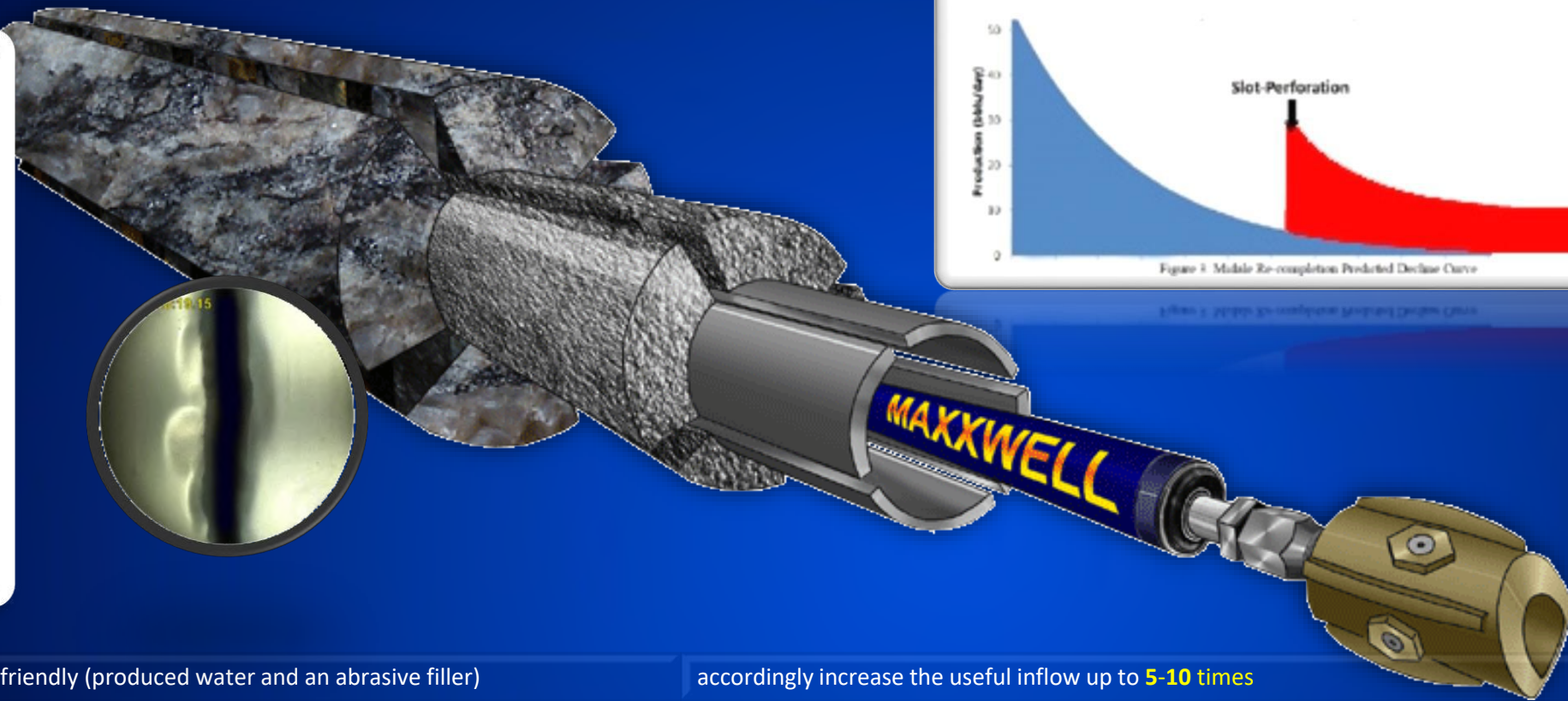
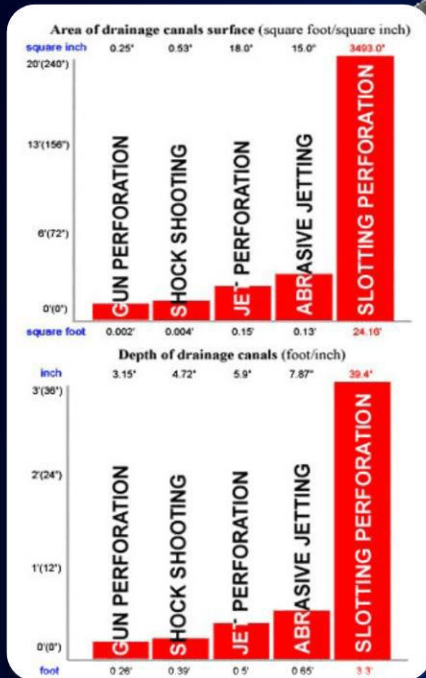

ecologically safe, environmentally friendly (produced water and an abrasive filler)

penetration depth is up to **1.5 m (5 feet)**

opening area per one linear meter up to **6 m<sup>2</sup> (2 nozzles)**, and **12 m<sup>2</sup> (4 nozzles)**

opening area per one linear foot up to **20 ft<sup>2</sup> (2 nozzles)**, and **40 ft<sup>2</sup> (4 nozzles)**

cutting speed is one linear foot per **60 min** (cased wells) and one linear foot per **30 min** (open hole)

simultaneous cutting **2, 3, and 4 slots** along the wellbore

no detonation impact, no casing damage, no cement cracks, no clog-up the formation borders

unloading of the annular compressive stress conditions in the near wellbore zone up to **50-100 %**

accordingly increase of permeability up to **30-50 %**

accordingly increase the useful inflow up to **5-10 times**

can be used in oil, gas, and injection wells

can be used in newly drilled and low productivity, low debit wells

can be used in vertical and horizontal wells, with tubing and coiled tubing

can be used in any formation (sandstone, carbonates, shale's, thinly interbedded, quicksand, etc.)

can be used near the water reservoirs (impossible to make a hydraulic fracturing)

extract more than **20 %** of additional oil from the layers with higher productivity

duration of the effect over **10 years**

make an excellent geometry for subsequent fracturing (if necessary)

## WHERE IS HYDRO-SLOTTING POSSIBLE TO USE ?

In sandstones, carbonates, shale's, thinly interbedded formations. In oil and gas, vertical and horizontal, newly drilled, low-debit and low productivity wells. In low-temperature and low-viscosity wells. It is certainly better to use hydro-slotting perforation for its intended purpose, as a way of opening casing, cement and productive formation with the effect of annular stress conditions unloading in newly drilled wells, than later treat problem wells. Near the water reservoirs, for subsequent hydraulic fracture and additional stimulation's methods (acoustic, cavitation, chemical treatment, electric, frequency, impact, impulse, laser, magnetic, oscillations, plasma, pneumatic, temperature, ultrasound, vacuum, vibrations, voltage, warming-up, wave, etc.) the efficacy and duration of effect which is directly depends on the size (area) of opening the casing, cement and productive formation.

### EXAMPLE - THINLY INTERBEDDED FORMATION

The picture below shows example of thinly interbedded formation (top and side view), similar to shale formation. Top view shows only one limited layer. How are you going to open this information ? Of course, by traditional methods - cumulative or jet perforation and, if not near aquifers, hydraulic fracturing.

Drilled well before the opening

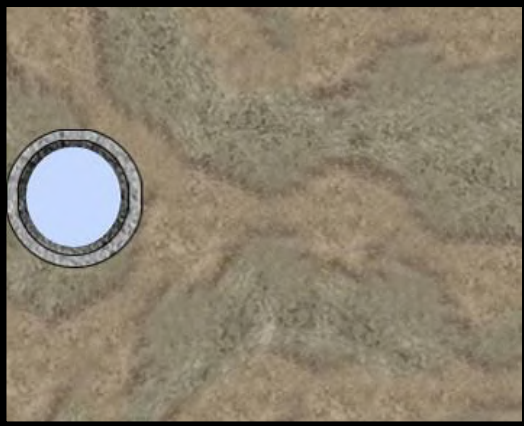

After cumulative or jet perforation

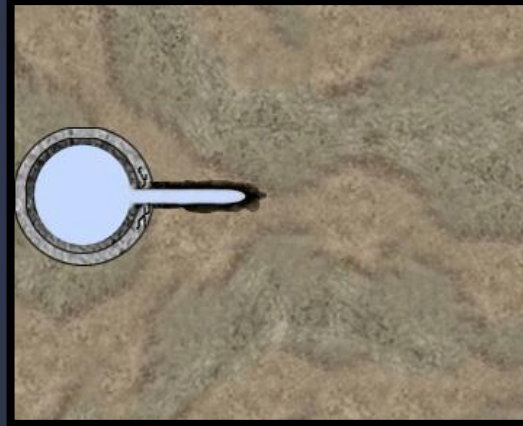

After subsequent hydraulic fracturing

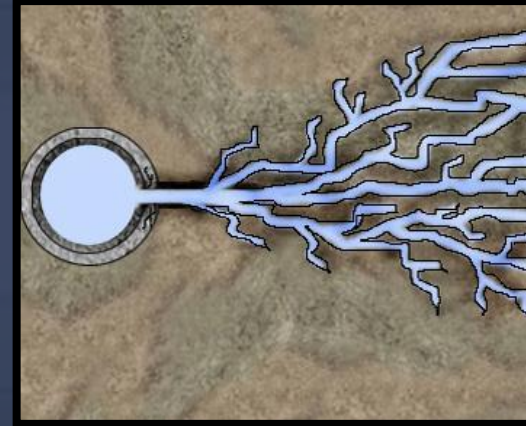

After hydro-slotting perforation

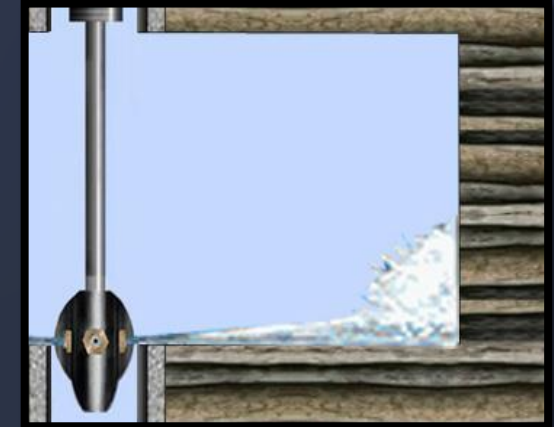
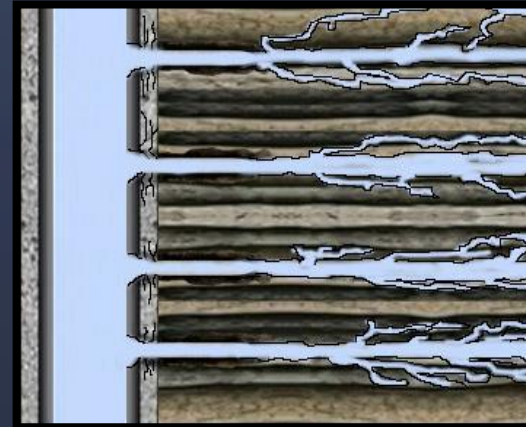
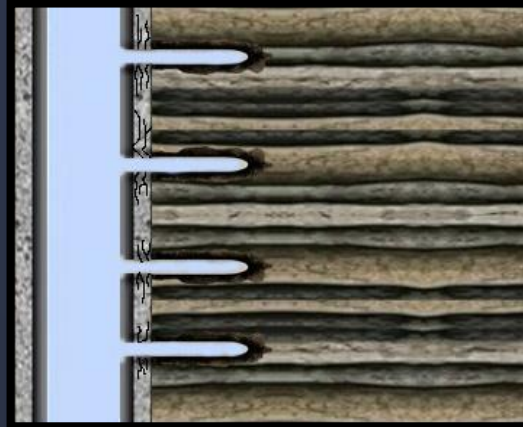
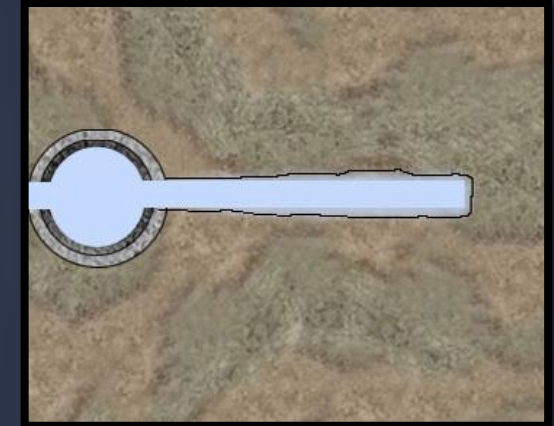

- Hydro-slotting perforation just cut through all the of thinly interbedded layers entirely and without residue, plus unloaded the annular stress conditions in the near wellbore zone.

## EXAMPLE - CRUMBLING SAND

Let's consider another case. Crumbling (losing) sand - a fairly common well's problem in some regions. Is it possible to treat this problem with hydro-slotting perforation? At first glance, this is not possible. Feed an abrasive under the high pressure into the well, which is already colmatated by crumbling sand! Let's look at it from a different perspective.

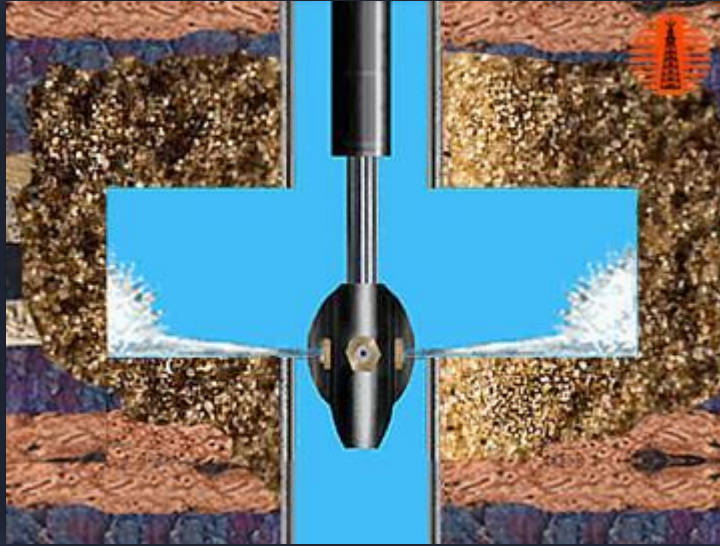

- Firstly, how to remove the sand through small holes in the casing? Yes, with water jets under high pressure, or by different methods of stimulation may clear the holes, but remove sand behind the casing and cement is impossible. It is necessary to cut casing and cement to clean sand from the entire colmatation zone.
- Second, the sand falls into the channels in the near wellbore under the action of rock pressure. Continuous slots along the wellbore allow unloading of the annular compressive stress-strain states around the wellbore zone. Rock pressure to the sand will be reduced, crumbling of sand will be weakened.
- Occurs unloading (discharging) of the stress conditions in the near wellbore zone (up to **50-100 %**). As a consequence the rock pressure on the sandy rocks in the near-wellbore area (in radius **~ 12-14 feet** around the well) become smaller, and sand stops to crumble.
- “**Breaking component**” of oil flow rate is reduced. It does not mean that the flow becomes less. Example. Suppose that through a hole in casing after cumulative perforation with the maximum diameter **~ 2”** and the area **~ 3.14 square feet** passes **1 barrel** of oil per hour (in the case of a broken casing after hydraulic fracturing the area of hole **~ 10-15 square feet**). One full slot after slotting perforation has an area of hole **~ 30-40 square feet**. Let the flow of oil through the **hole 40 square feet** will remain the same: **1 barrel** of oil per hour. But the total flow rate through the large hole will be less, respectively “**destructive component**” will also be less, respectively, the effect will be much longer.

## EXAMPLE - HORIZONTAL WELL

One more example of opening the productive layer in a horizontal wellbore with hydraulic fracturing and hydro-slotting perforation. Slots after hydro-slotting perforation are within the productive formation horizon (located along the productive horizon).

Drilled well before the operation



After perforation and subsequent hydraulic fracturing



After hydro-slotting perforation

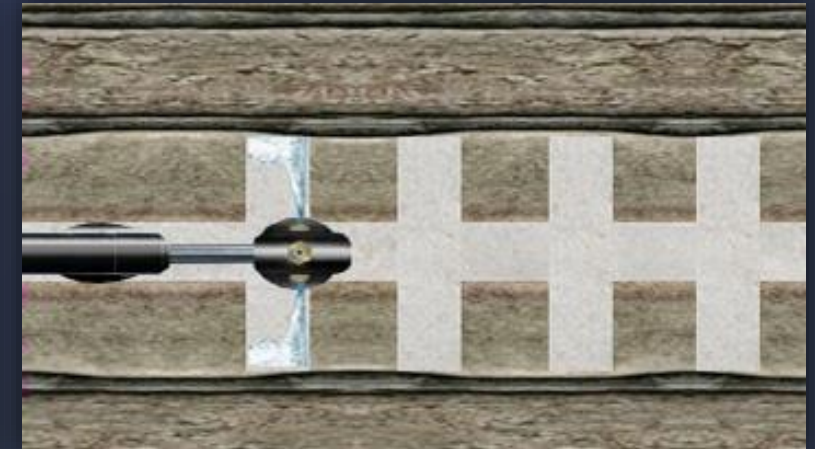

**Hydraulic fracturing** (fracking) - hydraulically pressurized liquid made of water, sand, and ... chemicals.

Hydraulic Fracturing is the most powerful method, creating very long cracks and micro cracks spread in the direction of the greatest fracture.

Fracturing relates to methods of opening the productive formation, but it **can be applied only after one of the known methods of opening the casing**:

**Shock-explosive**: bullet (gun perforation) and cumulative perforation;

**Unstressed**: methods of point perforation and continuous opening;

## Positive aspects:

- Very large area of opening;
- Large productive inflow (especially in the initial stage);

## Negative aspects:

- The process has practically no control;
- The process affects the other layers and zones;
- Cracks and micro cracks of large length extend the boundaries of producing formation and transferred to other layers;
- Coefficient of efficiency sometimes reduced up to **40 %** (within productive formation), the remaining **60 %** are harmful;
- Violation of the integrity of a producing formation;
- Combining unwanted productive and non-productive reservoirs;
- Generating unwanted flows;
- Pulling up the water with subsequent flooding of the productive layer;
- Reducing the life of the well.

Coefficient of efficiency of hydraulic fracturing in shale's or thinly interbedded layers, for example, is very low and financially not beneficial.

**Hydro-slotting perforation** - continuous moving jet slotting perforation.

Hydro-slotting perforation is the most effective method of opening the casing, cement and productive formation. Uses a special slotting perforation tool that produces linear motion with constant velocity of abrasive cutting jets along the wellbore, and without moving the tubing from the surface.

## Positive aspects:

- Ecologically safe, environmentally friendly (water and sand);
- Very long duration of effect (up to **15-20 years**);
- Opportunity of using near the water reservoirs (impossible to make a hydraulic fracturing);
- The process is controlled (length and depth of slots);
- **The process takes place within the productive formation, and not affects other layers and zones**;
- Large opening area, penetration depth is up to **5 feet**;
- No detonation impact, no casing damage, no cement cracks, no clog-up the formation in borders;
- Unloading the tangential circle stress conditions in the near wellbore zone up to **50-100 %**;
- Increases the collecting properties in the near wellbore zone;
- Increase of the drainage volume characteristics in more than **6 times**;
- Increase of permeability and accordingly increase the useful inflow up to **30-50 %**;
- Opportunity to use in any wells and in any formations;

## Negative aspects:

- The process is quite complicated in the performance;

Hydro-slotting perforation perfectly working in sandstones and carbonates, thinly interbedded formations, shale's, etc.

Coefficient of efficiency of HSP in shale's and thinly interbedded layers is very high.

## HYDRO-SLOTTING PERFORATION IS NOT A MAGIC WAND FOR ALL OCCASIONS

According to classification the hydro-slotting perforation relates to methods of opening the productive formation. Hydro-slotting perforation it is accurate, and quite effective method, but it is not a magic wand for all occasions. Necessary to understand all the advantages of this method based on the physics of the phenomena of unloading the annular compressive stress-strain states around the wellbore zone, depth of created slots, opening area of the formation, operating principle and so on.

If in the well oil or gas is over, or productive layers have watered (or cement has cracks for water overflows), then no method will help anymore. Or if the well is working perfectly and gives productive influx of hundreds barrels per day, then no method will increase such influx in twice (except additional new drilling).



### Cause of the fall of productive influx is a lot:

- Oil or gas is over
- Fall intrastate pressure
- Flooding of producing layer
- Chemical damage of the productive formation
- Incorrect grid drilling
- Incorrect development
- Incorrect exploitation
- Colmatation
- Poor hydrodynamic connection of the well with producing layer
- Low temperature, high viscosity, etc.

### In which wells can slotting perforation be used ?

- Oil, gas and injection wells
- Vertical and horizontal wells
- Newly drilled and old wells
- Sandstone, carbonate, shale, etc. formations
- Shallow and deep wells
- High-temperature and low-temperature wells
- Low-viscosity and high-viscosity, etc.

### Is preferable:

- Newly drilled wells, or old wells with the following criteria:
- Old wells with the following criteria:
- Having no problems with the water during operation;
- Total period of operation not exceeding **10-15 years**;
- Designed exclusively via gun perforation or cumulative perforation;
- Designed exclusively via hydraulic fracturing, but without water during the whole period of operation;
- The operational reservoirs one or two;
- Having a very good productive inflow in early or mid-operation;
- Currently idle or even abandonment;
- Currently Inflow **0-0.5-1.0-1.5-2.0** bod;





# Statistics (productive inflow before HSP, and after HSP)

| well name | formation type | well depth (ft.) | porosity (%) | permeability Y (Darcy) | inflow Before HSP (bbl./day) | inflow After HSP (bbl./day) | inflow Increase (bbl./day) | inflow Gain (%) | estimated HSP cost per well | daily inflow @ \$40 bbl./well | yearly profit @ \$40 bbl./well | ROI (days) |
|-----------|----------------|------------------|--------------|------------------------|------------------------------|-----------------------------|----------------------------|-----------------|-----------------------------|-------------------------------|--------------------------------|------------|
| C1-20     | sand/clay      | 1285             | 15           | N/A                    | 0.3                          | 30                          | 29.7                       | 10000%          | \$62,850                    | \$1,200                       | \$357,150                      | 53         |
| C1-21     | sand/clay      | 4529             | 15           | N/A                    | 10                           | 80                          | 70                         | 800%            | \$95,290                    | \$3,200                       | \$1,024,710                    | 30         |
| Church    | sandstone      | 6608             | 17           | N/A                    | 266                          | 477                         | 211                        | 179%            | \$116,080                   | \$19,080                      | \$6,561,920                    | 7          |
| Clifton   | sandstone      | 10609            | 18           | N/A                    | 25                           | 200                         | 175                        | 800%            | \$156,090                   | \$8,000                       | \$2,643,910                    | 20         |
| X-12      | sandstone      | 16066            | 11           | 0.002                  | 70                           | 212                         | 142                        | 303%            | \$210,660                   | \$8,480                       | \$2,757,340                    | 25         |
| X-15      | sandstone      | 14989            | 11           | 0.002                  | 53                           | 250                         | 197                        | 472%            | \$199,890                   | \$10,000                      | \$3,300,110                    | 20         |
| 3907      | sandstone      | 3420             | 19           | 0.41                   | 25                           | 115                         | 90                         | 460%            | \$84,200                    | \$4,600                       | \$1,525,800                    | 19         |
| 3911      | sandstone      | 5695             | 22           | 0.33                   | 13                           | 65                          | 52                         | 500%            | \$106,950                   | \$2,600                       | \$803,050                      | 42         |
| 3917      | sandstone      | 4679             | 21           | 0.35                   | 10                           | 180                         | 170                        | 1800%           | \$96,790                    | \$7,200                       | \$2,423,210                    | 14         |
| 3919      | sandstone      | 4600             | 23           | 0.31                   | 11                           | 95                          | 84                         | 864%            | \$96,000                    | \$3,800                       | \$1,234,000                    | 26         |
| 3921      | clay           | 3573             | 20           | 0.44                   | 9                            | 200                         | 191                        | 2222%           | \$85,730                    | \$8,000                       | \$2,714,270                    | 11         |
| 3922      | clay           | 5802             | 22           | 0.3                    | 10                           | 55                          | 45                         | 550%            | \$108,020                   | \$2,200                       | \$661,980                      | 50         |
| 3923      | clay           | 7797             | 23           | 0.29                   | 8                            | 80                          | 72                         | 1000%           | \$127,970                   | \$3,200                       | \$992,030                      | 40         |
| 3925      | clay           | 7653             | 15           | 0.005                  | 50                           | 350                         | 300                        | 700%            | \$126,530                   | \$14,000                      | \$4,773,470                    | 10         |
| 3951      | clay           | 4074             | 23           | 0.38                   | 29                           | 100                         | 71                         | 345%            | \$90,740                    | \$4,000                       | \$1,309,260                    | 23         |
| 3970      | sandstone      | 11204            | 10           | 0.002                  | 53                           | 185                         | 132                        | 349%            | \$162,040                   | \$7,400                       | \$2,427,960                    | 22         |
| 4007      | sandstone      | 4679             | 21           | 0.44                   | 10                           | 180                         | 170                        | 1800%           | \$96,790                    | \$7,200                       | \$2,423,210                    | 14         |
| 1452      | sandstone      | 4600             | 23           | 0.31                   | 11                           | 95                          | 84                         | 864%            | \$96,000                    | \$3,800                       | \$1,234,000                    | 26         |
| 1463      | sandstone      | 7855             | 21           | 0.35                   | 20                           | 85                          | 65                         | 425%            | \$128,550                   | \$3,400                       | \$1,061,450                    | 38         |
| 1487      | sandstone      | 4345             | 25           | 0.35                   | 25                           | 80                          | 55                         | 320%            | \$93,450                    | \$3,200                       | \$1,026,550                    | 30         |
| 1550      | sandstone      | 6508             | 19           | 0.29                   | 10                           | 75                          | 65                         | 750%            | \$115,080                   | \$3,000                       | \$934,920                      | 39         |
| 1590      | sandstone      | 7133             | 16           | 0.2                    | 40                           | 275                         | 235                        | 688%            | \$121,330                   | \$11,000                      | \$3,728,670                    | 12         |
| 1705      | clay           | 4350             | 26           | 0.35                   | 30                           | 130                         | 100                        | 433%            | \$93,500                    | \$5,200                       | \$1,726,500                    | 18         |
| 1775      | sandstone      | 6875             | 15           | 0.11                   | 50                           | 220                         | 170                        | 440%            | \$118,750                   | \$8,800                       | \$2,961,250                    | 14         |
| 1828      | sandstone      | 11130            | 10           | 0.003                  | 65                           | 140                         | 75                         | 215%            | \$161,300                   | \$5,600                       | \$1,798,700                    | 29         |
| 1861      | sandstone      | 10243            | 12           | 0.004                  | 61                           | 158                         | 97                         | 259%            | \$152,430                   | \$6,320                       | \$2,059,570                    | 25         |
| 2532      | sandstone      | 4679             | 21           | 0.44                   | 10                           | 180                         | 170                        | 1800%           | \$96,790                    | \$7,200                       | \$2,423,210                    | 14         |
| 2539      | sandstone      | 6109             | 20           | 0.28                   | 19                           | 89                          | 70                         | 468%            | \$111,090                   | \$3,560                       | \$1,134,910                    | 32         |
| 2801      | sandstone      | 7835             | 22           | 0.46                   | 18                           | 135                         | 117                        | 750%            | \$128,350                   | \$5,400                       | \$1,761,650                    | 24         |
| 2810      | sandstone      | 6165             | 23           | 0.31                   | 14                           | 98                          | 84                         | 700%            | \$111,650                   | \$3,920                       | \$1,260,350                    | 29         |
| 2815      | sandstone      | 7350             | 21           | 0.4                    | 18                           | 110                         | 92                         | 611%            | \$123,500                   | \$4,400                       | \$1,416,500                    | 29         |
| 2887      | sandstone      | 4600             | 23           | 0.31                   | 11                           | 95                          | 84                         | 864%            | \$96,000                    | \$3,800                       | \$1,234,000                    | 26         |
| 2894      | clay           | 7797             | 23           | 0.31                   | 8                            | 80                          | 72                         | 1000%           | \$127,970                   | \$3,200                       | \$992,030                      | 40         |
| 2895      | clay           | 8170             | 17           | 0.008                  | 45                           | 260                         | 215                        | 578%            | \$131,700                   | \$10,400                      | \$3,508,300                    | 13         |
| 2896      | clay           | 3450             | 27           | 0.48                   | 40                           | 110                         | 70                         | 275%            | \$84,500                    | \$4,400                       | \$1,455,500                    | 20         |
| 2915      | sandstone      | 5158             | 12           | 0.19                   | 75                           | 160                         | 85                         | 213%            | \$101,580                   | \$6,400                       | \$2,138,420                    | 16         |
| X-3-X     | sandstone      | 7660             | 13           | 0.1                    | 55                           | 89                          | 34                         | 162%            | \$126,600                   | \$3,560                       | \$1,119,400                    | 36         |
| X-4-X     | sandstone      | 9398             | 9            | 0.002                  | 43                           | 110                         | 67                         | 256%            | \$143,980                   | \$4,400                       | \$1,396,020                    | 33         |
| X-5-X     | sandstone      | 4845             | 19           | 0.45                   | 12                           | 190                         | 178                        | 1583%           | \$98,450                    | \$7,600                       | \$2,561,550                    | 13         |

| well name | formation type | well depth (ft.) | porosity (%) | permeability Y (Darcy) | inflow Before HSP (bbl./day) | inflow After HSP (bbl./day) | inflow Increase (bbl./day) | inflow Gain (%) | estimated HSP cost per well | daily inflow @ \$40 bbl./well | yearly profit @ \$40 bbl./well | ROI (days) |
|-----------|----------------|------------------|--------------|------------------------|------------------------------|-----------------------------|----------------------------|-----------------|-----------------------------|-------------------------------|--------------------------------|------------|
| 411       | sandstone      | 4783             | 19           | 0.43                   | 15                           | 118                         | 103                        | 787%            | \$97,830                    | \$4,720                       | \$1,554,170                    | 21         |
| 424       | sandstone      | 10219            | 23           | 0.31                   | 11                           | 100                         | 89                         | 909%            | \$152,190                   | \$4,000                       | \$1,247,810                    | 39         |
| 425       | sandstone      | 7805             | 22           | 0.33                   | 10                           | 70                          | 60                         | 700%            | \$128,050                   | \$2,800                       | \$851,950                      | 46         |
| 426       | sandstone      | 10715            | 14           | 0.004                  | 60                           | 205                         | 145                        | 342%            | \$157,150                   | \$8,200                       | \$2,712,850                    | 20         |
| 110       | sandstone      | 3155             | 15           | 0.01                   | 50                           | 225                         | 175                        | 450%            | \$81,550                    | \$9,000                       | \$3,068,450                    | 10         |
| 115       | sandstone      | 8315             | 10           | 0.02                   | 75                           | 225                         | 150                        | 300%            | \$133,150                   | \$9,000                       | \$3,016,850                    | 15         |
| 117       | sandstone      | 9552             | 11           | 0.002                  | 50                           | 145                         | 95                         | 290%            | \$145,520                   | \$5,800                       | \$1,884,480                    | 26         |
| 946       | sandstone      | 5158             | 12           | 0.19                   | 75                           | 160                         | 85                         | 213%            | \$101,580                   | \$6,400                       | \$2,138,420                    | 16         |
| X-AA      | sandstone      | 10243            | 12           | 0.004                  | 61                           | 158                         | 97                         | 259%            | \$152,430                   | \$6,320                       | \$2,059,570                    | 25         |
| X-AB      | sandstone      | 4679             | 21           | 0.44                   | 10                           | 180                         | 170                        | 1800%           | \$96,790                    | \$7,200                       | \$2,423,210                    | 14         |
| X-AC      | sandstone      | 6109             | 20           | 0.28                   | 19                           | 89                          | 70                         | 468%            | \$111,090                   | \$3,560                       | \$1,134,910                    | 32         |
| X-AD      | sandstone      | 7835             | 22           | 0.46                   | 18                           | 135                         | 117                        | 750%            | \$128,350                   | \$5,400                       | \$1,761,650                    | 24         |
| X-AE      | sandstone      | 6165             | 23           | 0.31                   | 14                           | 98                          | 84                         | 700%            | \$111,650                   | \$3,920                       | \$1,260,350                    | 29         |
| X-AF      | sandstone      | 7350             | 21           | 0.4                    | 18                           | 110                         | 92                         | 611%            | \$123,500                   | \$4,400                       | \$1,416,500                    | 29         |
| X-AJ      | sandstone      | 4600             | 23           | 0.31                   | 11                           | 95                          | 84                         | 864%            | \$96,000                    | \$3,800                       | \$1,234,000                    | 26         |
| 5156      | sandstone      | 11204            | 10           | 0.002                  | 53                           | 185                         | 132                        | 349%            | \$162,040                   | \$7,400                       | \$2,427,960                    | 22         |
| 5157      | sandstone      | 4679             | 21           | 0.44                   | 10                           | 180                         | 170                        | 1800%           | \$96,790                    | \$7,200                       | \$2,423,210                    | 14         |
| 5158      | sandstone      | 4600             | 23           | 0.31                   | 11                           | 95                          | 84                         | 864%            | \$96,000                    | \$3,800                       | \$1,234,000                    | 26         |
| 5159      | sandstone      | 7855             | 21           | 0.35                   | 20                           | 85                          | 65                         | 425%            | \$128,550                   | \$3,400                       | \$1,061,450                    | 38         |
| 5160      | sandstone      | 4345             | 25           | 0.35                   | 25                           | 80                          | 55                         | 320%            | \$93,450                    | \$3,200                       | \$1,026,550                    | 30         |
| 5161      | sandstone      | 6508             | 19           | 0.29                   | 10                           | 75                          | 65                         | 750%            | \$115,080                   | \$3,000                       | \$934,920                      | 39         |
| 5162      | sandstone      | 7133             | 16           | 0.2                    | 40                           | 275                         | 235                        | 688%            | \$121,330                   | \$11,000                      | \$3,728,670                    | 12         |
| 197       | clay           | 4350             | 26           | 0.35                   | 30                           | 130                         | 100                        | 433%            | \$93,500                    | \$5,200                       | \$1,726,500                    | 18         |
| 33-58     | sandstone      | 6875             | 15           | 0.11                   | 50                           | 220                         | 170                        | 440%            | \$118,750                   | \$8,800                       | \$2,961,250                    | 14         |
| 33-59     | sandstone      | 11130            | 10           | 0.003                  | 65                           | 140                         | 75                         | 215%            | \$161,300                   | \$5,600                       | \$1,798,700                    | 29         |
| 33-60     | sandstone      | 10243            | 12           | 0.004                  | 61                           | 158                         | 97                         | 259%            | \$152,430                   | \$6,320                       | \$2,059,570                    | 25         |
| 33-61     | sandstone      | 4679             | 21           | 0.44                   | 10                           | 180                         | 170                        | 1800%           | \$96,790                    | \$7,200                       | \$2,423,210                    | 14         |
| 33-62     | sandstone      | 6109             | 20           | 0.28                   | 19                           | 89                          | 70                         | 468%            | \$111,090                   | \$3,560                       | \$1,134,910                    | 32         |
| 33-63     | sandstone      | 7835             | 22           | 0.46                   | 18                           | 135                         | 117                        | 750%            | \$128,350                   | \$5,400                       | \$1,761,650                    | 24         |
| 33-64     | sandstone      | 6165             | 23           | 0.31                   | 14                           | 98                          | 84                         | 700%            | \$111,650                   | \$3,920                       | \$1,260,350                    | 29         |
| 33-65     | sandstone      | 7350             | 21           | 0.4                    | 18                           | 110                         | 92                         | 611%            | \$123,500                   | \$4,400                       | \$1,416,500                    | 29         |
| 1134      | sandstone      | 4600             | 23           | 0.31                   | 11                           | 95                          | 84                         | 864%            | \$96,000                    | \$3,800                       | \$1,234,000                    | 26         |
| 1135      | sandstone      | 4679             | 21           | 0.44                   | 10                           | 180                         | 170                        | 1800%           | \$96,790                    | \$7,200                       | \$2,423,210                    | 14         |
| 1136      | sandstone      | 4600             | 23           | 0.31                   | 11                           | 95                          | 84                         | 864%            | \$96,000                    | \$3,800                       | \$1,234,000                    | 26         |
| 1137      | sandstone      | 7855             | 21           | 0.35                   | 20                           | 85                          | 65                         | 425%            | \$128,550                   | \$3,400                       | \$1,061,450                    | 38         |
| 1138      | sandstone      | 4345             | 25           | 0.35                   | 25                           | 80                          | 55                         | 320%            | \$93,450                    | \$3,200                       | \$1,026,550                    | 30         |
| 1139      | sandstone      | 6508             | 19           | 0.29                   | 10                           | 75                          | 65                         | 750%            | \$115,080                   | \$3,000                       | \$934,920                      | 39         |
| 1140      | sandstone      | 7133             | 16           | 0.2                    | 40                           | 275                         | 235                        | 688%            | \$121,330                   | \$11,000                      | \$3,728,670                    | 12         |

OIL AND GAS WELL SLOTTING PERFORATION PROFESSIONAL SERVICE

# MAXXWELL PRODUCTION

CONTINUOUS MOVING JET SLOTTING PERFORATION TECHNOLOGY FOR VERTICAL AND HORIZONTAL WELLS

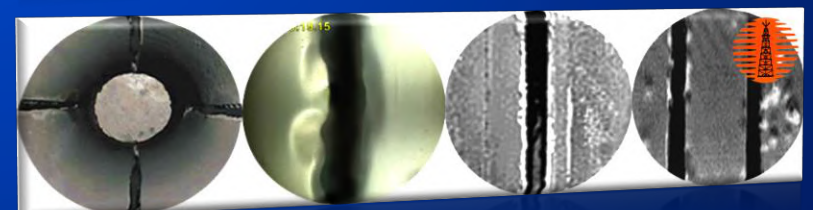





# MAXXWELL PRODUCTION

## About us and our company

[Maxwell Production](#) is a professional service company, providing [hydro-slotting perforation](#) (HSP) - reasonably efficient Technology for increase productive inflow in newly drilled, and old low productive oil and gas wells. operates in the United States and Canada territories.

Maxwell Production is the only company on this Territory, which during many years (since 2008 as HSP-Team, and since 2011 under "Maxwell Production" mark, to present time) really and practically providing HSP service in the real and existing oil and gas wells (in contrast to other phone-paper-online companies, dealing with a theory-philosophical-self-presentation activity only).

Maxwell Production operates by own slotting perforation HSP equipment, developed and produced by own design, according to own Patents, confirmed and protected by United States Patent and Trademark Offices.

Our recent valid and active Patents:

- [US 8863823](#) (Granted October 21, 2014):

"Universal underground hydro-slotting perforation system, controlled by working fluid pressure, for activation and intensification of gas, oil and hydro-geological wells"

- [Patent US 8240369](#) (Granted August 14, 2012):

"Slot-perforating system for oil, gas and hydro-geological wells"

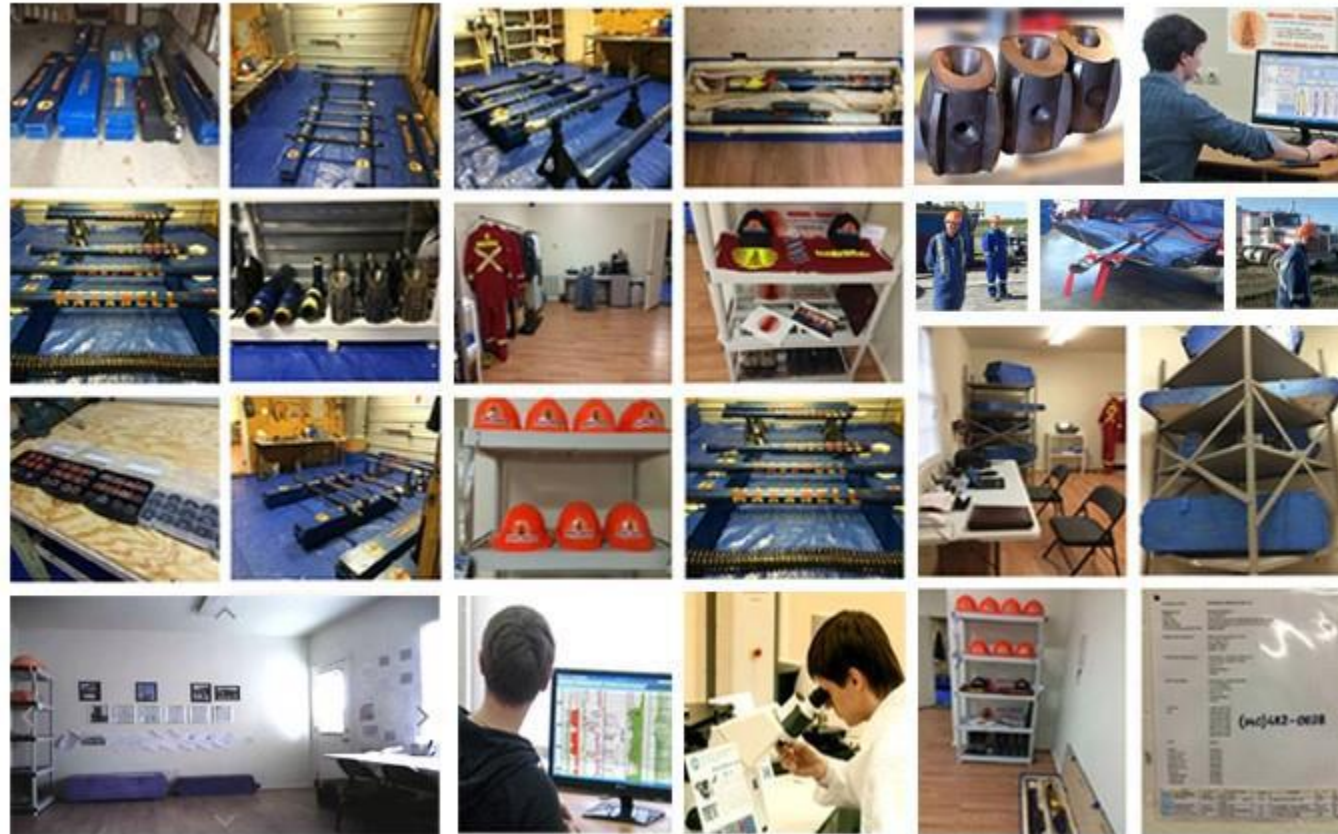

All preparations for HSP projects, as Geophysical and Geological analyzes, calculation of remaining reserves, calculation of technological parameters for HSP re-completion, preparations and testing of HSP tool/equipment, organization, work with third-parties service-companies, conducting HSP processes, engineering

and management, supervision, control/monitoring, accident prevention, and responsibility, are doing on their own Maxwell Production's staff only (Geophysics and Geology, computer scientists, Engineers and HSP specialists/experts, laboratory technicians, managers and marketers.

- [US20130105163](#) (Application May 2, 2013):

"Method of opening productive formation and a working fluid"

Maxwell Production has the Rights to Patent's License's for the use of Maxwell-tool (HSP tool/equipment), supply, and teach/train HSP specialists/experts.

Maxwell's [HSP tool/equipment](#) and parts are constantly being improved (it is a long and painstaking work of manufacture, testing, and checking on the real working oil and gas wells), and is currently (really) tested and accepted by many oil and gas companies (as "Chevron USA", "Baker Hughes USA", and other), and officially registered by API (American Petroleum Institute).

Since the beginning of 2015 Maxwell Production designed and created special HSP tool/equipment for horizontal wells (analogues do not exist).

For geophysical and geological analysis, and for calculation of remaining reserves and technological parameters HSP operations, Maxwell Production uses own computer programs.

The Company does not have any investors, and operates on own equity only, received from provided HSP service Maxwell Production works directly with oil and gas operators and services companies only.



# MAXXWELL PRODUCTION

## Registrations

### Maxxwell Production, Inc. (Canada)

|                              |  |                    |
|------------------------------|--|--------------------|
| Company name:                | Maxxwell Production, Inc. (Canada)                           | registered in 2012 |
| Registration address:        | 72 Beechbrooke way<br>Aurora, ON L4G 6N7<br>Canada           |                    |
| Ontario Corporation Number:  | 1883972  |                    |
| Business number:             | 837400241  |                    |
| GST/HST:                     | 837400241RT0001  |                    |
| Export/Import:               | 837400241RM0001  |                    |
| Query Importer Bond Response | MAXPROAUR  |                    |
| Importer name:               | Maxxwell Production, Inc.                                    |                    |
| Importer number:             | 143901-31845   |                    |
| Toll free:                   | 1-800-696-5721   |                    |
| Tel:                         | (647) 724-4308   |                    |
| Email:                       | <a href="mailto:internet@rogers.com">internet@rogers.com</a> |                    |
| Website:                     | <a href="http://www.maxxwell.ca">www.maxxwell.ca</a>         |                    |

### Maxxwell Production, LLC (United States)

|                             |   |                    |
|-----------------------------|---|--------------------|
| Company name:               | Maxxwell Production, LLC. (USA)   | registered in 2014 |
| Registration address:       | 848 N. Rainbow Blvd, # 5353<br>Las Vegas, NV 89107<br>United States   |                    |
| Ontario Corporation Number: | 1883972   |                    |
| Business ID:                | NV20141386654   |                    |
| LLC Status                  | "S"   |                    |
| GST/HST:                    | 837400241RT0001   |                    |
| FEIN (TAX ID):              | 35-2509442  |                    |
| NAICS Code:                 | 213112 (Support Activities for Oil and Gas Operations)  |                    |
| SIC Code:                   | 1382 (Oil & Gas Field Exploration Services)   |                    |
| D-U-N-S:                    | 080013706 (Dun & Bradstreet D-U-N-S)  |                    |
| Importer name:              | Maxxwell Production, LLC  |                    |
| Toll free:                  | 1-800-696-5721  |                    |
| Tel:                        | (702) 932-1905  |                    |
| Email:                      | <a href="mailto:info@maxxwell.us">info@maxxwell.us</a> , <a href="mailto:maxxwell@maxxwell.net">maxxwell@maxxwell.net</a> |                    |
| Website:                    | <a href="http://www.maxxwell.us">www.maxxwell.us</a>  |                    |

### Office/Workshop/Laboratory (United States)

|                          |  |  |
|--------------------------|--|--|
| Laboratory address:      | 11555 HWY US-380, # 205<br>Krum, TX 76249<br>United States   |  |
| SIC Code:                | 1382 (Oil & Gas Field Exploration Services)                  |  |
| SAFELAND USA Certificate | 16615213   |  |
| Toll free:               | 1-800-696-5721   |  |
| Tel:                     | (940) 368-1192   |  |
| Email:                   | <a href="mailto:maxxwell@rogers.com">maxxwell@rogers.com</a> |  |
| Website:                 | <a href="http://www.maxxwell.net">www.maxxwell.net</a>       |  |

### Official Representatives

|                              |  |  |
|------------------------------|--|--|
| Admiralty Oils, LTD          | 1103, 201 1st Ave South<br>Saskatoon, SK S7K1J5<br>Canada              | (306) 651-5013, (306) 222-5013<br><a href="mailto:g.hardage@admiraltyoils.com">g.hardage@admiraltyoils.com</a> |
| Maxxwell Services UK, LTD    | 22 Priory Rd<br>Huntingdon, Cambridgeshire<br>PE29 1JN United Kingdom  | +44 0 1908 388136<br><a href="mailto:e.martin@eamconsultants.net">e.martin@eamconsultants.net</a>              |
| Maxxwell Production, LLC USA | 616 Corporate Way 2, 4201<br>Valley Cottage, NY 10989<br>United States | for correspondence only<br><a href="mailto:maxxwell@maxxwell.us">maxxwell@maxxwell.us</a>                      |



# MAXXWELL PRODUCTION



Anatoli Nikouline  
CEO at Maxxwell Production, LLC (USA)  
Oil & Gas well HSP Professional Engineer  
(HSP process Expert, HSP tool inventor)



Nikolay Korvet  
Mining Engineer, Candidate of  
Geological-Mineralogical Sciences. HSP  
Expert since 1980 (HSP inventor's Team)



Tatiana Silagina  
Leading Engineer Geophysicist & Geologist,  
Candidate of Geology and Mineralogical  
Sciences, Head of Geophysicist Department

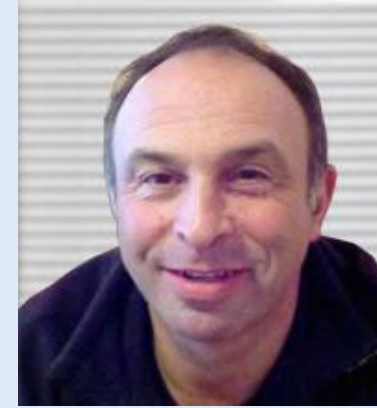

Edward Rubinstein  
General Manager, HSP Project Organizer,  
Coordinator, Synchronizer, Computer Engineer

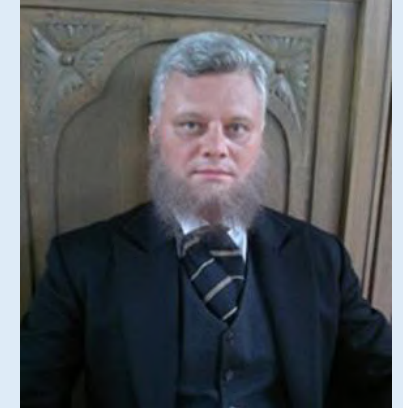

Roman Kulichov  
Senior Science and Technology Advisor,  
Candidate of Geology and Mineralogical  
Sciences (HSP Technology investor's Team)



Anjelika Gretskaia  
CEO at Maxxwell Production, Inc. (Canada)  
Oil & Gas well HSP Chemical Engineer



Sergey Palagnyuk  
Well-site HSP Project Service Supervisor  
(HSP process Expert)



Yuri Goya  
Electronic/Computer/Mechanical Engineer,  
Post-Designer of HSP equipment



Al Clinton  
Electical and Mechanical Engineer,  
Installer and Tester of HSP equipment

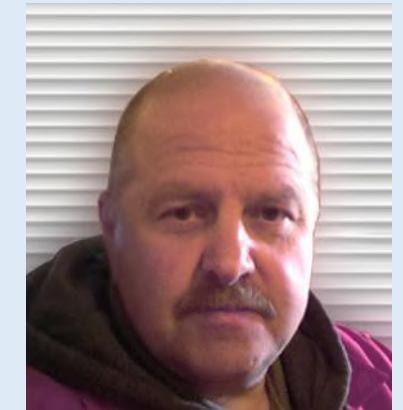

Mikhail Kurgatnikov  
Marketer, Financial Analyst, legality and  
documentation, negotiator, scheduler



# MAXXWELL PRODUCTION

## Intellectual Properties

|           |                                |  |                  |
|-----------|--------------------------------|--|------------------|
| • Patent  | <a href="#">US 8863823</a>     | Universal underground hydro-slotting perforation system, controlled by working fluid pressure, for activation and intensification of gas, oil and hydro-geological wells | October 21, 2014 |
| • Patent  | <a href="#">US 8240369</a>     | Slot-perforating system for oil, gas and hydro-geological wells  | August 14, 2012  |
| • Patent  | <a href="#">US 20130105163</a> | Method of opening productive formation and a working fluid   | May 2, 2013      |
| • Patent  | Application                    | Hydro-slotting perforation tool/equipment for horizontal wells   | January 10, 2014 |
| • Patent  | Application                    | Hydro-slotting perforation without special tool/equipment  | May 15, 2014     |
| • Program | Computer Program               | Calculation of remaining reserves by cumulative production method.   | January 20, 2013 |
| • Program | Computer Program               | Calculation of all technical and technological parameters for hydro-slotting perforation process.  | January 25, 2013 |

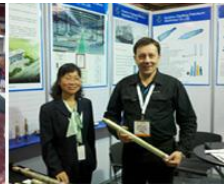
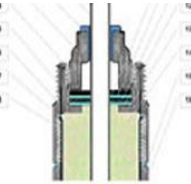
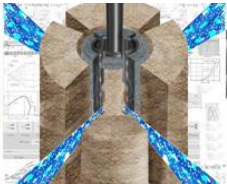



# MAXXWELL PRODUCTION

## Legality

- Maxxwell-tool (HSP tool/equipment) registered in API (American Petroleum Institute), tested and accepted by many oil and gas companies (as "Chevron USA", "Baker Hughes USA", and other)

## Team

- Maxxwell Production team consists only high quality long-standing practice (not book's theory) experience in hydro-slotting perforation and in Oil and Gas Industry.

## HSP experience

- All company's staff also have experience and specialization in increase productive inflows of oil and gas well's field, and in hydro-slotting perforation technology direction.

## Safety/Security, PPE

- Each specialist, participate directly in the work on the well-site mandatory has personal medical insurance coverage (including travel), and special personal protective equipment (PPE):
- Active and tested H2S Gas Indicator to determine the level of permissible (fatal) values of toxic gases
- Special protective body suit (dielectric, oil-resistant, non-flammable, protection level # 2 minimum)
- Personal protective helmet
- Personal protective boots
- Personal protective rubber boots
- Personal protective glasses
- Personal protective gloves
- Personal protective rubber gloves
- Personal protective Face Shield (protect the entire face area from chemical splashes and flying objects)
- Personal protective Dust Mask (protect from inhaling airborne dust particles, fibers or mechanically generated particles)
- Personal protective Cartridge Respirator (protect from airborne contaminants and toxic gases)
- Personal protective Self Contained Breathing Apparatus (protect when require oxygen during hazard assessment)

## Professional Liability

| Professional Service Liability Insurances      |              |
|--|--------------|
| Commercial General Liability                   |              |
| Body Injury                                    | \$ 1,000.000 |
| Property Damage                                | \$ 1,000.000 |
| Inclusive Limits                               | \$ 1,000.000 |
| Products Completed Operations (per Occurrence) | \$ 1,000.000 |
| Personal & Advertising Injury                  | \$ 1,000.000 |
| Pollution Liability                            |              |
| Aggregate Limit                                | \$ 1,000.000 |
| Per each Incident                              | \$ 1,000.000 |
| Umbrella Liability                             |              |
| Aggregate Limit                                | \$ 4,000.000 |
| Per Occurrence Limit                           | \$ 4,000.000 |
| Control of Well Insurance                      |              |
| Each Occurrence                                | \$ 5,000.000 |
| Combined Single Limit                          | \$ 5,000.000 |
| Each Occurrence                                | \$ 1,000.000 |

## Educations/specializations

- All company's staff have a mandatory higher education (Bachelor's degree) in one or more following technical specialties:
- Geophysicist
- Geologist
- Engineer

## Engineering specializations

| Engineering specialization in the following areas: |
|--|
| Mining   |
| Geology  |
| Mechanics  |
| Physics  |
| Hydraulics   |
| Chemistry  |
| Electronics  |
| Mineral resources                                  |
| Metallurgy   |

## Licensing/Certification

- For lead, manage and supervise, control and correct the HSP process directly on well-site our specialists pass the required annual certifications:
- SAFELand USA
- H2S Awareness Certificate
- WHIMS Workplace Hazardous Materials Information System Certificate
- TDG Transportation of Dangerous Goods by Ground Certificate
- IADC RIGPass
- First Aid Certificate

## Professional Memberships

- Our HSP expert/specialists are members of specialized organizations:
- Society of Petroleum Engineers (SPE)
- United Inventors Association of America (UIA)
- Ontario Association of Certified Engineering Technicians and Technologists (OACETT)
- Saskatchewan Applied Science Technologists and Technicians (SASTT), and other





# MAXXWELL PRODUCTION

## Maxxwell Production Contracts

| Chevron USA               |  |  |
|---------------------------|--|--|
| 1                         | Chevron Technology Ventures a Division of Chevron USA Inc.<br>Two Allen Center, 1200 Smith Street, 30th Floor, Houston, TX 77002 USA (Tel: XXX-XXX-XXXX)                       | (3 years)<br>June 11, 2015   |
| 2                         | Confidentiality Agreement with Chevron USA Inc.<br>Two Allen Center, 1200 Smith Street, 30th Floor, Houston, TX 77002 USA (Tel: XXX-XXX-XXXX)                                  | (3 years)<br>June 11, 2015   |
| 3                         | Master Well Services Contract # CW XXXXXXXX<br>Chevron North America Exploration and Production Company<br>Chevron Centre, 1400 Smith Street, TX 77002 USA (Tel: XXX-XXX-XXXX) | (October 12, 2015) (3 years)<br>October 12, 2015                             |
| 4                         | Service Order # CV XXXXXXXX/001<br>Chevron North America Exploration and Production Company<br>Chevron Centre, 1400 Smith Street, TX 77002 USA (Tel: XXX-XXX-XXXX)             | for 3 years (October 12, 2015 - October 11, 2018)<br>10/12/2015 - 10/11/2018 |
| 5                         | Chevron Wolverine Project<br>Chevron USA Inc. Mid-Continent Business Unit<br>McElroy FMT, Crane County, TX 79731   | (since September 28, 2015)<br>September 28, 2015                             |
| 6                         | Slot Perforation Program for Chevron USA (Maxxwell Production, LLC)<br>848 N. Rainbow Blvd, # 5353, Las Vegas, NV United States 89107 (Tel: 1-800-696-5721)                    | (July 6, 2015)<br>July 6, 2015   |
| Shell USA                 |  |  |
| 7                         | Upstream production and wells Engineering<br>2800 Post Oak Blvd, Suite 2300, Houston, TX 77056 USA   | In Process   |
| Baker Hughes USA          |  |  |
| 8                         | Baker Hughes Oilfield Operational, Inc.<br>17021 Aldine Westfield Road, Houston, TX 77073 USA  | August 27, 2015 (for 5 years)<br>August 27, 2015                             |
| 9                         | Baker Hughes Master Supplier Agreement<br>17021 Aldine Westfield Road, Houston, TX 77073 USA   | August 27, 2015 (for 5 years)<br>August 27, 2015                             |
| C & J Energy Services USA |  |  |
| 10                        | Master Purchase Agreement for Goods and Services<br>450 Gears Road, Suite 790, Houston, TX 77067 USA   | In Project   |
| 11                        | Nabors Completion & Production Services Co.<br>450 Gears Road, Suite 790, Houston, TX 77067 USA  | In Project   |
| Halliburton USA           |  |  |
| 12                        | Halliburton Energy Services, Inc.<br>3000 N. Sam Houston Pkwy., E. Houston, TX 77032 USA   | In Process   |
| 13                        | Master Purchase Agreement for Goods and Services # XXXXXXXXXXX MPA (CMS X-7-15)<br>Halliburton Energy Services, Inc.<br>3000 N. Sam Houston Pkwy., E. Houston, TX 77032 USA    | In Process   |

| Redux Energy, LLC (USA)                   |   |  |
|---|---|--|
| 14  | Agreement on Cooperation<br>963 Topsy Lane, Suite 306-261, Carson City, NV 89705 USA  | (January 15, 2014)<br>January 15, 2014   |
| 15  | Cooperation & Confidentiality Non-Disclosure Agreement<br>963 Topsy Lane, Suite 306-261, Carson City, NV 89705 USA  | (January 15, 2014)<br>January 15, 2014   |
| Darby Holding, Inc. (USA)                 |   |  |
| 16  | Partnership Agreement<br>1401 Dove Street, 260, Newport Beach, CA 92660 USA (Tel: (XXX) XXX-XXXX, (XXX) XXX-XXXX)   | (June 15, 2016)<br>June 15, 2016         |
| 17  | Subcontracting Partnership Agreement<br>1401 Dove Street, 260, Newport Beach, CA 92660 USA (Tel: (310) 428-1414, (714) 381-4963)  | (June 25, 2016)<br>June 25, 2014         |
| Oil Production Intensification, LLC (USA) |   |  |
| 18  | Agreement for Joint and Mutually Completed Project for the secondary Development of oil well in North Dakota<br>848 N. Rainbow Blvd, 838, Las Vegas, NV 89107 USA   | (September 1, 2014)<br>September 1, 2014 |
| Maxxwell Production, LLC (USA)            |   |  |
| 19  | Agreement between Maxxwell Production, LLC. and Maxxwell production, Inc.<br>Mutual Cooperation Agreement with Canadian Maxxwell Production, Inc.<br>848 N. Rainbow Blvd, 5353, Las Vegas, NV 89107 USA (Tel: 1-800-696-5721) | (June 11, 2014)<br>June 11, 2014         |
| Admiralty Oils Ltd. (Canada)              |   |  |
| 20  | Advisory Services Agreement<br>1103, 201 1st Avenue South, Saskatoon, Canada SK S7K 1J5 (Tel: (XXX) XXX-XXXX, (XXX) XXX-XXXX)   | (January 15, 2015)<br>January 15, 2015   |
| 21  | Priority Agreement for Marketing and Services<br>1103, 201 1st Avenue South, Saskatoon, Canada SK S7K 1J5 (Tel: (XXX) XXX-XXXX, (XXX) XXX-XXXX)   | (February 12, 2015)<br>February 12, 2015 |
| 22  | Cooperation Relationship and Horizontal Hydro-slotting Patent<br>1103, 201 1st Avenue South, Saskatoon, SK Canada S7K 1J5 (Tel: (XXX) XXX-XXXX, (XXX) XXX-XXXX)   | (May 27, 2015)<br>May 27, 2015           |
| JVCO (Canada)                             |   |  |
| 23  | Joint Venture and Shareholders Agreement<br>"101259686 Saskatchewan Ltd", "Secure Gen Resources Inc.", "Artisan Consulting Services Ltd"  | (March 1, 2014)<br>March 1, 2014         |
| 24  | Joint Venture and Shareholders Agreement<br>"101259686 Saskatchewan Ltd", "Secure Gen Resources Inc.", "Artisan Consulting Services Ltd", "Highmark Exploration Inc.", "University of Saskatchewan"                           | (June 18, 2014)<br>June 18, 2014         |



# MAXXWELL PRODUCTION

## Maxxwell Production's Contracts

| Maxxwell Well Services UK LTD (United Kingdom)                   |  |  |
|--|--|--|
| 25   | Agency Agreement<br>20-22 Wenlock Road, London N1 7GU United Kingdom +44 0 XXXX XXXXXX, +44 0 XXXXXXXXXX   | (March 22, 2016)<br>March 22, 2016         |
| EnMatrix Consultants DMCC (EnMatrix) (United Arab Emirates)      |  |  |
| 26   | MOU & Confidentiality Non-Disclosure Agreement<br>DMCC, Dubai Multi Commodity Center, Dubai, United Arab Emirates<br>Jumeirah Lake Towers, P.O. Box 74721, Dubai, UAE ('EnMatrix') | (September 28, 2014)<br>September 28, 2014 |
| Hydrocarbon Solutions (Oman)                                     |  |  |
| 27   | Exclusive & Confidentiality Non-Disclosure Agreement<br>P.O. Box 550, Al Khoudh 132, Muscat, Sultanate of Oman (Tel: +XXX XXXXXXXX)  | (October 10, 2013)<br>October 10, 2013     |
| Seaharvest Oil and Gas Services (Egypt)                          |  |  |
| 28   | MOU & Confidentiality Non-Disclosure Agreement<br>"Seaharvest Group" Villa 54, Road 57, 1 <sup>st</sup> District, Zone 7, 5 <sup>th</sup> Settlement, New Cairo, Egypt             | (April 24, 2013)<br>April 24, 2013         |
| Abex Offshore Equipment Leasing and Supplies (AOELS) (Hong Kong) |  |  |
| 29   | MOU & Confidentiality Non-Disclosure Agreement<br>903 Luard Road, Wan Chai, Hong Kong (Tel: XXX-XXXXXXX, XX-XXXXXXX)   | (February 22, 2013)<br>February 22, 2013   |
| Standard Industrial Lease Agreement (Texas) (United States)      |  |  |
| 30   | Standard Industrial Lease Agreement<br>11555 Hwy 380W # 205, Krum, TX, United States, 76249  | (October 20, 2015)<br>October 20, 2015     |

## Recent Maxxwell Production Projects

|    | well name                                  | well type       | location             | customer          |
|----|--|-----------------|----------------------|-------------------|
| 1  | UPTONZ-XXX (Chevron)                       | oil well        | Midland, TX          | Chevron USA       |
| 2  | 199JTM-XXX-6W (Chevron)                    | injection well  | Midland, TX          | Chevron USA       |
| 3  | 199JTM-XXX-6W (Chevron)                    | injection well  | Midland, TX          | Chevron USA       |
| 4  | SE Mathews XX (Chevron)                    | oil well        | Carthage, TX         | Chevron USA       |
| 5  | Brawnwer XX-15 (Chevron)                   | oil well        | Carthage, TX         | Chevron USA       |
| 6  | Redman-XD1X                                | oil well        | Gainesville, TX      | Redux Energy      |
| 7  | Redman-XD2X                                | oil well        | Gainesville, TX      | Redux Energy      |
| 8  | O'Neal Heirs-XXXX                          | oil well        | Gainesville, TX      | Redux Energy      |
| 9  | Beachy-X2X 095XXXXX                        | oil well        | Brownville, Nebraska | Branch Production |
| 10 | Beachy-X3X 095XXXXX                        | oil well        | Brownville, Nebraska | Branch Production |
| 11 | Beachy-X4X 095XXXXX                        | oil well        | Brownville, Nebraska | Branch Production |
| 12 | Beachy-X5X 095XXXXX                        | oil well        | Brownville, Nebraska | Branch Production |
| 13 | Beachy-X7X 095XXXXX                        | oil well        | Brownville, Nebraska | Branch Production |
| 14 | Admiralty Welwyn 11-XX-XXX-31W1            | oil well        | Saskatchewan, Canada | Admiralty Oils    |
| 15 | Admiralty Welwyn 09-XX-XXX-31W1            | oil well        | Saskatchewan, Canada | Admiralty Oils    |
| 16 | Admiralty Barracuda Pinto 03-XX-XXX-03W2   | oil well        | Saskatchewan, Canada | Admiralty Oils    |
| 17 | Admiralty Barracuda Pinto 02-XX-XXX-05W2   | oil well        | Saskatchewan, Canada | Admiralty Oils    |
| 18 | Admiralty West Kingsford 04-XX-XXX-7W2     | oil well        | Saskatchewan, Canada | Admiralty Oils    |
| 19 | Admiralty Welwyn 09-XX-XXX-31W1 horizontal | horizontal well | Saskatchewan, Canada | Admiralty Oils    |
| 20 | Chautauqua-X1X                             | gas well        | Westfield, NY        | Chautauqua Oils   |
| 21 | Brown-Amerando-Brigantino-XX               | gas well        | Rio Vista, CA        | GoEnergy, Inc.    |

Maxxwell Production has non-disclosure Agreements with each company, for which makes the services, so we do not have rights to disclose the information regarding wells, productive inflows, results or similar issues, at least without special permission from the Customer. Given the fact, that potential Customers-Investors in any case will need information on specific results, we received verbal permissions from previous Customers, who have already made successful re-completion of their oil wells with HSP technology and Maxxwell-tool, to disclose their contact information. We provide this information below.



### Admiralty Oils, Ltd

Quinton Hardage P. Eng.  
**President & CEO at Admiralty Oils, Ltd**  
 1103, 201 - 1st Ave S  
 Saskatoon, SK. S7J 1K5 Canada  
 (306) 222-8886, (306) 651-5013  
[q.hardage@admiraltyoils.com](mailto:q.hardage@admiraltyoils.com)  
[www.admiraltyoils.com](http://www.admiraltyoils.com)



### Redux Energy, LLC

Christian Weber, President  
 963 Topsy Lane, Suite 306-261  
 Carson City, Nevada  
 89705-8417 USA  
 206.910.0124 Skype: cw77777  
[cw@reduxenergy.com](mailto:cw@reduxenergy.com)  
[www.reduxenergy.com](http://www.reduxenergy.com)

### Additional information:

<http://admiraltyoils.com/wp-content/uploads/2013/03/Admiralty-Presentations.pdf>  
<http://www.stockwatch.com/News/Item.aspx?bid=Z-C:AKC-2051209&symbol=AKC&region=C>  
<http://admiraltyoils.com/wp-content/uploads/2013/03/Press-Release-Announcing-Update-to-QT-March-21-2013.pdf>  
<http://admiraltyoils.com/wp-content/uploads/2013/03/Admiralty-2.0-Confidential-Presentation-Feb-2013.pdf>



# MAXXWELL PRODUCTION

## HSP tool/equipment, consumables and spare parts

| HSP tool/equipment, consumables and spare parts |  |            |
|---|--|------------|
| 1   | Underground hydraulic block (hydraulic engine) 5.2', OD 3.5" for vertical wells (assembly)   | 10 sets    |
| 2   | Underground hydraulic block (hydraulic engine) 2.5', OD 3.5" for horizontal wells (assembly)   | 1 set      |
| 3   | Body of hydraulic block (body of hydraulic engine) 5.2', OD 3.5" for vertical wells (assembly)   | 5 sets     |
| 4   | Body of hydraulic block (body of hydraulic engine) 3.5', OD 3.5" for horizon. wells (assembly)   | 3 set      |
| 5   | Internal rod for hydraulic block (hydraulic engine) with a piston seat 5.0', OD 1.5" for v/wells   | 10 pieces  |
| 6   | Internal rod for hydraulic block (hydraulic engine) with a piston seat 3.0', OD 1.5" for h/wells   | 10 piece   |
| 7   | Spring for return block Maxxwell-SP70X2.5, 6.1', OD 3.0" for vertical wells  | 25 pieces  |
| 8   | Spring for return block Maxxwell-SP70X2.5, 4.0', OD 3.0" for horizontal wells  | 4 pieces   |
| 9   | Main piston for underground hydraulic block (hydraulic engine), OD 3.0"  | 10 pieces  |
| 10  | Floating piston for underground hydraulic block (hydraulic engine), OD 3.0"  | 10 pieces  |
| 11  | Upper sealed cover for underground hydraulic block (hydraulic engine), OD 3.5"   | 3 pieces   |
| 12  | Bottom cover for underground hydraulic block (hydraulic engine), OD 3.5"   | 10 pieces  |
| 13  | Solid shank for underground hydraulic block (hydraulic engine) 3.0', OD 3.5"   | 7 pieces   |
| 14  | Sectional shank for underground hydraulic block (hydraulic engine) 3.0', OD 3.5"   | 8 pieces   |
| 15  | Back cover for floating piston for underground hydraulic block, OD 3.0"  | 11 pieces  |
| 16  | Sand-mud remover for upper sealed cover for underground hydraulic block, OD 3.0"   | 50 pieces  |
| 17  | Sand-mud remover for bottom sealed cover for floating piston (hydraulic block), OD 3.0"  | 50 pieces  |
| 18  | Solid perforator Maxxwell-P120ES4-D-1/2 (ergonomic one-piece solid metal D-1/D-2 for 4/2 nozzles and ball valve seat), OD 4.0" (for casing 4.5") | 20 pieces  |
| 19  | Solid perforator Maxxwell-P120ES4-D-1/2 (ergonomic one-piece solid metal D-1/D-2 for 4/2 nozzles and ball valve seat), OD 5.0" (for casing 5.5") | 10 pieces  |
| 20  | Solid carbide nozzle Maxxwell-NL1-07-06-0.2CONE, OD=5.1 mm with hardness 7.5   | 200 pieces |
| 21  | Nozzle-holder (hardy/T <sup>o</sup> ) Maxxwell-NH1.2-1-1   | 80 pieces  |
| 22  | Copper sealing ring Maxxwell-CRO.1   | 65 pieces  |
| 23  | Solid plug Maxxwell-Plg-0.08 for perforators   | 55 pieces  |
| 24  | Sintered metal ball OD=1.5" for tubing testing   | 30 pieces  |
| 25  | Steel S-40 metal valve ball OD=1.0" for perforator's seat  | 35 pieces  |
| 26  | Internal copper washers OD=3.0"  | 25 pieces  |
| 27  | Sealing copper washers OD=1.0"   | 40 pieces  |
| 28  | Adapters with seat for connections equipment with tubing or coiled tubing in assortment  | 10 pieces  |
| 29  | O-rings in stock (plastic, Fluor plastic, rubber, metal)   | 85 pieces  |
| 30  | Consumables and spare parts in stock, in assortment  | assortment |
| 31  | Control flow (dosing device) for main piston in the underground hydraulic block OD=0.5"  | 25 pieces  |

## Additional HSP tool/equipment, consumables and spare parts

| Additional HSP tool/equipment, consumables and spare parts |  |            |
|--|--|------------|
| 1  | Underground hydraulic block (hydraulic engine) 7.0', OD 3.8" for vertical wells (assembly)       | 5 sets     |
| 2  | Body of hydraulic block (body of hydraulic engine) 7.0', OD 3.8" for vertical wells (assembly)   | 5 sets     |
| 3  | Internal rod for hydraulic block (hydraulic engine) with a piston seat 5.5', OD 2.0" for v/wells | 5 pieces   |
| 4  | Spring for return block 8.5', OD 3.8" for vertical wells   | 20 pieces  |
| 5  | Main piston for underground hydraulic block (hydraulic engine), OD 3.8"                          | 5 pieces   |
| 6  | Floating piston for underground hydraulic block (hydraulic engine), OD 3.5"                      | 5 pieces   |
| 7  | Upper sealed cover for underground hydraulic block (hydraulic engine), OD 3.8"                   | 5 pieces   |
| 8  | Bottom cover for underground hydraulic block (hydraulic engine), OD 3.8"                         | 5 pieces   |
| 9  | Solid shank for underground hydraulic block (hydraulic engine) 4.0', OD 3.8"                     | 5 pieces   |
| 10   | Sectional shank for underground hydraulic block (hydraulic engine) 4.0', OD 3.8"                 | 5 pieces   |
| 11   | Back cover for floating piston for underground hydraulic block, OD 3.5"                          | 5 pieces   |
| 12   | Sand-mud remover for upper sealed cover for underground hydraulic block, OD 3.5"                 | 5 pieces   |
| 13   | Sand-mud remover for bottom sealed cover for floating piston (hydraulic block), OD 3.5"          | 5 pieces   |
| 14   | Perforator for 4/2 nozzles and ball valve seat, OD 5.0" (for casing 5.5")                        | 20 pieces  |
| 15   | Solid carbide nozzle OD=5.1 mm with hardness 7.0   | 60 pieces  |
| 16   | Nozzle-holder  | 60 pieces  |
| 17   | Copper sealing ring  | 60 pieces  |
| 18   | Plug for perforators   | 20 pieces  |
| 19   | Sintered metal ball OD=1.5" for tubing testing   | 1 pieces   |
| 20   | Steel S-40 metal valve ball OD=1.0" for perforator's seat  | 15 pieces  |
| 21   | Internal copper washers OD=3.5"  | 5 pieces   |
| 22   | Sealing copper washers OD=1.5"   | 5 pieces   |
| 23   | Adapters with seat for connections equipment with tubing or coiled tubing in assortment          | 5 pieces   |
| 24   | O-rings in stock (plastic, Fluor plastic, rubber, metal)   | 5 pieces   |
| 25   | Consumables and spare parts in stock, in assortment  | assortment |
| 26   | Control flow (dosing device) for main piston in the underground hydraulic block OD=0.5"          | 5 pieces   |





# MAXXWELL PRODUCTION

## Laboratory equipment

(for assembly and disassembly of the equipment, and testing it at a certain temperature and pressure)

| Laboratory equipment |   |            |
|----------------------|---|------------|
| 1                    | Hand oil pump for pressure 10000 psi (680 atmospheres)  | 1 set      |
| 2                    | Airtight oil pressure chamber for testing of control flow (dozing devices)                      | 1 set      |
| 3                    | Heater temperature (up to 100°C or 212°C air type)  | 2 sets     |
| 4                    | Laboratory equipment for oil (viscometers, pumps, meters, plastic or glassware) in stock        | assortment |
| 5                    | Laboratory equipment for rock (ultraviolet lamp, laser and electronic thermometers) in stock    | assortment |
| 6                    | Laboratory tools (microscope, various magnifiers, camcorder, stopwatch, and tweezers)           | assortment |
| 7                    | Laboratory appointments (safes, work metal desks, vise, extinguishers, absorbent) in stock      | assortment |
| 8                    | Auxiliary assortment (pipe fittings for loosening-tightening of equipment) in stock             | assortment |
| 9                    | Office equipment (computer, laptop, printer, copier, fax, internet, communication means)        | assortment |
| 10                   | Tool in assortment (electric/hand drills, files, screwdrivers, pliers, saws, wrenches, hammers) | assortment |
| 11                   | Hydraulic oil, fuel, diesel, gasoline, lubricant, grease, various aerosols) in stock            | assortment |

## Business and travel equipment

(for business travel for development 1-5 oil or gas wells with slotting perforation method)

| Business and travel equipment |  |            |
|-------------------------------|--|------------|
| 1                             | Underground hydraulic slotting perforation equipment (unassembled by parts) and ready to work        | 1 set      |
| 2                             | Mobile stands Jacks for assembly-disassembly and testing of the equipment on the work-well-site      | 1 set      |
| 3                             | Tool assortment (electric and hand drills, files, screwdrivers, pliers, saws, wrenches, hammers)     | 2 sets     |
| 4                             | Mobile auxiliary assortment (pipe fittings for loosening-tightening of equipment) in stock           | assortment |
| 5                             | Hand oil pump for pressure 10000 psi (680 atmospheres)   | 1 set      |
| 6                             | Mobile airtight oil pressure chamber for testing of dozing devices                                   | 1 set      |
| 7                             | Mobile laboratory equipment for oil (viscometers, pumps, meters, plastic or glassware) in stock      | assortment |
| 8                             | Mobile laboratory equipment for rock (ultraviolet lamp, laser and electronic thermometers) in stock  | assortment |
| 9                             | Mobile laboratory tools (microscope, various magnifiers, camcorder, stopwatch, and tweezers)         | assortment |
| 10                            | Mobile laboratory appointments (safes, work metal desks, vise, extinguishers, absorbent) in stock    | assortment |
| 11                            | Mobile office equipment (computer, laptop, printer, copier, internet, communication means)           | assortment |
| 12                            | Mobile stock of hydraulic oil, fuel, diesel, gasoline, lubricant, grease, various aerosols) in stock | assortment |
| 13                            | Mobile kitchen, uniform and coveralls for staff, individual protection means, advertising items      | assortment |





Project for re-completion low productive oil wells in West Louisiana deposit-fields (Caddo, De Soto) with using Hydro-slotting perforation technology (HSP) in combination with additional methods of stimulation.

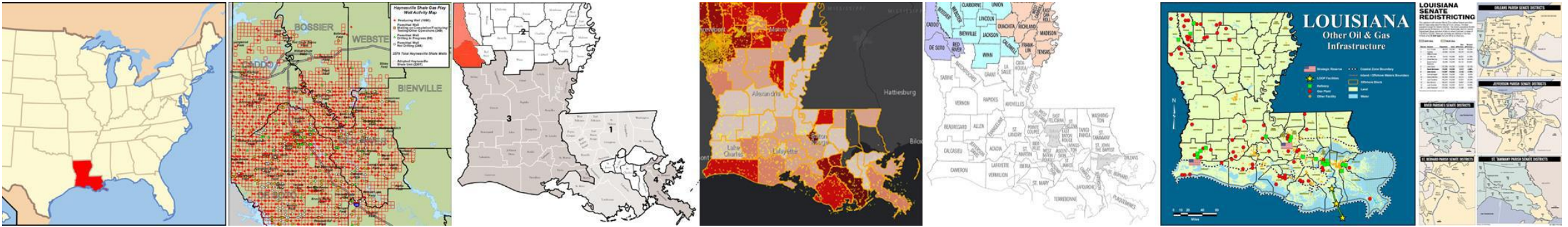

In the presented Investment Project for re-completion low productive oil wells was considered in detail and selected two deposit-fields in West Louisiana: Caddo and De Soto. This choice was based on several factors: **1** - Historical factors, **2** - Geological/Geophysical factors, **3** - Comparison of different technologies of wells re-completion, **4** - Choice of optimal techniques applied to considered deposit-fields, **5** - Financial factor, and finally **6** - Payback period. Hydro-slotting perforation (HSP) technology was chosen as the main re-completion method (and hydraulic fracturing as auxiliary and subsequent stimulation method) for the following reasons: **1** - Productive layers have a very large thickness (100-200 ft.), but the productive formation represents by a thin-interbedded carbonate structure (chalk, shale, clay), **2** - HSP open all the pores (layers, formation) completely, unload stress conditions in the near wellbore zone, increases permeability, and accordingly increases the productive flow to the wellbore. After HSP will be open a large drainage area (through the casing, cement, and further in to the productive formation), and accordingly established a good hydrodynamic connection well with the productive layer, removed colmatation, and sets a good geometry for subsequent hydraulic fracturing. **3** - This wells historically do not have water flooding problems, so gentle hydraulic fracturing (sand and water only) can be applied without risk of flooding the productive formation. Hydraulic fracturing will create additional long and continuous cracks and micro-cracks. **4** - Period of operation/exploitation of considered oil wells is big enough (50-80 years), so to create/increase internal pressure of the productive formation/layer will necessary to develop the near/neighboring injection well. **5** - Given the fact, that the operation/exploitation of consideration wells was conducted by traditional/conventional methods, estimate of remaining reserves in this deposit-fields shows near 50% not extracted productive reserves.





# LOUISIANA. CADDO DEPOSIT FIELD

## Project for oil wells recovery and production increase

### 1. Historical factor

Main deposit-field of Louisiana consists of 62 fields with various oil, gas, injection and hydro-geological wells, a large portion of which were developed in early 40's of 20-th century during the last "oil boom". Methods of oil wells development haven't varied much and were primarily reduce to simple drilling. The wells were not cased and wellbore remained open.

In the early 50's simple "gun perforation" method was used to open the productive formation in uncased and already cased wells.

Early 60's marked a development of Oil and Gas Industry in the neighboring Texas with the introduction of hydraulic fracturing and chemical treatment. However, In Louisiana new technology hasn't been used on such a wide scale and therefore many of today's existing oil and gas wells have still retained most of their original reserves.



The field in consideration, Caddo, located in the Northwestern part of the State, is no different from a general "picture" of oil/gas wells State of Louisiana. Most of its oil/gas wells are old, have been exploited since 40's-50's and developed by cumulative perforation methods (gun perforation through the foot) with no damages by hydraulic fracturing, chemical treatments or other stimulating methods and no water in the wellbore. Some wells still continue to work at minimum rates till now.

According to available information from Oil and Gas Division of Louisiana State, Caddo oil/gas field wells in question were developed in 45-47's, and performance information for these wells is only became available since 1977 and later. We can assume that for 30 years' period of exploitation (1947-1977) these wells produced oil and gas of no less (and most likely even greater) than in already known 38-year exploitation period (1977-2015). These wells analysis can only be done based on a data of last 38 years (1977- 2015).

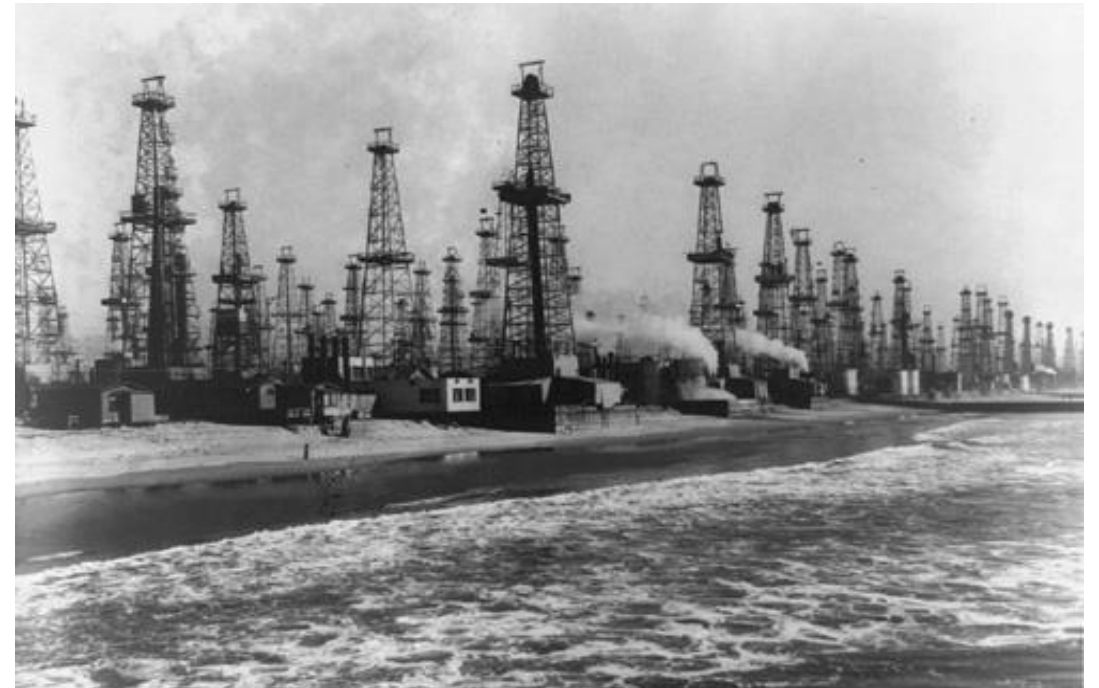



## 2. Geological factor.

The following common characteristics are observed among most of the wells:

- Period of exploitation - about 68 years (with last 38 years recorded)
- Development - cumulative perforation (gun perforation shots through the foot)
- Minimal use of hydraulic fracturing and chemical treatment
- Main productive intervals according to a basic (main) productive formations are 1350-1500' and 7050-7170' (this factor also defines basic depth of existing wells)
- Most wells produce oil and gas (pipe's separation)
- Minimum inflows are at zero mark
- Average maximum inflows up to 80 bbl./day for oil and up to 200 mcf/day for gas

Currently productive inflows have been significantly reduced to 0-2 bbl./day, although according to 2013 data, the productive inflows were up to 17 bbl./day for oil and up to 70 mcf/day for gas. There was also presence of paraffin at that condition. Maintenance of current oil/gas wells is coming to a critical level of financial disadvantages.

Based on an analysis of the past productive inflow information available from "Oil and Gas Conservation of Louisiana State", the reduction in a productive inflow has occurred gradually and in accordance with a classic geological graphs of exhaustion of deposit fields (or colmatation of productive formations); there is still some excessive internal pressure of the productive formation existing today. Given all of the above facts, it's been concluded that total productive stocks of Caddo deposit field are colossal and is worth to be developed.

The productive formation of exploited intervals consists of deposits of hard chalk (chalk with oil/gas) at 1335-1355' and hard shale (shale with oil/gas) at 1463-1500', together with mixture of solid clay sediments. This is dense, thin-interbedded carbonate structure with clay inclusions and with a pretty good porosity and permeability, having large hardness.

In a past, the primary methods of development of the productive formation in these wells were cumulative perforation (gun perforation shots through the foot) with subsequent chemical acid treatment baths (for carbonate deposits), and in some cases with a use of hydraulic fracturing.

The following pictures describe an effect of cumulative perforations (or hydraulic fracturing) in dense thin-interbedded carbonate structure with all mentioned above inclusions.



**INITIAL OPENING WITH GUN OR CUMULATIVE PERFORATION**

| depth   | area                 | cement             | border          | mixing     | unloading  |
|---------|----------------------|--------------------|-----------------|------------|------------|
| (1)     | (2)                  | (3)                | (4)             | (5)        | (6)        |
| 0.15 m  | 0.05 m <sup>2</sup>  | destroyed (cracks) | formed (melted) | not occurs | not occurs |
| 0.5 ft. | 0.5 ft. <sup>2</sup> |                    |                 |            |            |

Gun or cumulative perforation occurs the impact, deformation of casing, destruction and formation of cracks in cement that become longer and deeper especially after subsequent fracturing. Also gun or cumulative perforation creates a stable melted border. Unloading the stress conditions in the near wellbore zone is not happening.



**INITIAL OPENING WITH ABRASIVE JET'S POINT PERFORATION**

| depth | area               | cement    | border | mixing | unloading |
|-------|--------------------|-----------|--------|--------|-----------|
| (1)   | (2)                | (3)       | (4)    | (5)    | (6)       |
| 0.3 m | 0.1 m <sup>2</sup> | not       | not    | not    | not       |
| 1 ft. | 1 ft. <sup>2</sup> | destroyed | formed | occurs | occurs    |

Abrasive jet (point) perforation not deforms the casing, does not destroys the cement (keeps the integrity of the cement sheath), and does not forms the borders in the opening productive formation zone, but the penetration depth not exceeding 1 ft. (0.3 m). Unloading the stress conditions in the near wellbore zone is not happening.



**INITIAL OPENING WITH HYDRO-MECHANICAL PERFORATION**

| depth         | area                      | cement    | border | mixing | unloading |
|---------------|---------------------------|-----------|--------|--------|-----------|
| (1)           | (2)                       | (3)       | (4)    | (5)    | (6)       |
| up to 0.7 m   | up to 5 m <sup>2</sup>    | not       | not    | not    | unloading |
| up to 2.5 ft. | up to 18 ft. <sup>2</sup> | destroyed | formed | occurs | occurs    |

Hydro-mechanical (non-abrasive) slotting perforation (HMSP) does not deforms the casing, does not destroys the cement (keeps the integrity of the cement sheath), and does not forms the borders in the opening productive formation zone. Penetration up to 2.5 ft. (0.7 m) and drainage opening area up to 18 ft<sup>2</sup> per linear foot, or 5 m<sup>2</sup> per one linear meter (with simultaneous formation of four slots). Occurs unloading of the stress conditions in the near wellbore zone.



**INITIAL OPENING WITH HYDRO-SLOTTING (ABRASIVE) PERFORATION**

| depth       | area                      | cement    | border | mixing | unloading |
|-------------|---------------------------|-----------|--------|--------|-----------|
| (1)         | (2)                       | (3)       | (4)    | (5)    | (6)       |
| up to 1.5 m | up to 12 m <sup>2</sup>   | not       | not    | not    | unloading |
| up to 5 ft. | up to 40 ft. <sup>2</sup> | destroyed | formed | occurs | occurs    |

Hydro-slotting (abrasive) perforation (HSP) does not deforms the casing, does not destroys the cement (keeps the integrity of the cement sheath), and does not forms the borders in the opening productive formation zone. Penetration up to 5 ft. (1.5 m) and drainage opening area up to 40 ft<sup>2</sup> per linear foot, or 12 m<sup>2</sup> per one linear meter (with simultaneous formation of four slots). Occurs unloading of the stress conditions in the near wellbore zone. HMSP and HSP are environmentally friendly and only the methods of the initial opening the casing, cement and productive formations with unloading stress conditions in the near wellbore zone.



**HYDRAULIC FRACTURING**

| depth | area | cement       | border     | mixing        | unloading  |
|-------|------|--------------|------------|---------------|------------|
| (1)   | (2)  | (3)          | (4)        | (5)           | (6)        |
| ~     | ~    | questionable | not formed | mixing layers | not occurs |

Hydraulic fracturing is the most powerful method of opening a productive formation. Application is possible only after prior opening of the casing (initial opening). It forms deep cracks and micro cracks, the direction of which defies prediction, integrates productive and unproductive formations, "pulls" the nearest water. Good results after HMSP and HSP, which sets the follow geometry for hydraulic fracturing.

Comparative characteristics of the main initial opening methods clearly shows, that the most effective and meets all the required parameters of Geomechanics are HMSP (hydro-mechanical slotting perforation) and HSP (hydro-slotting perforation). The second, even more efficient because it uses abrasive sand. Wells which initially developed with using such effective opening methods (HMSP and HSP) continue to "work" 10 -15 and more years.



## 2. Geological factor.

(continuation)

Each shot (in these cases gun perforation shots through the foot was used) creates depth of up to 6 inches and drainage area of 18 sq. inches. Negative effects: detonation impact, damaged casing, cracked cement and borders clogging (which was partially removed by an afterward acid treatment baths of carbonate deposits).

Caddo's productive formations thickness of deposit field reaches 80-100'. Application of 4 shots per foot which corresponds to 400 shots per 100 feet and drainage area of up to 7200 sq. inches (50 sq. feet) for each well. This is a highest possible drainage zone of an opening of productive formation by using the above method.

According to the information from Oil and Gas Division of the Louisiana State, only 30-50' in these wells productive layers were opened, which corresponds to roughly 18-30 sq. feet. Given the drainage zone productive formation opening and taking into an account a cumulative colmatation of the wells in question, someone could conclude that during 68 years of their exploitation only 10% of the well's productive capacity has been used.

Based on our calculations a remaining oil and gas reserves of Caddo deposit field – there is an additional potential of about 30% in oil and 60% in gas for each well developed during 1977–2015, and about 50% in oil and 80% in gas for each well developed during 1947-1977. In a monetary variant (for today's oil prices at \$40/bbl.) this option can yield more than 75,000-100,000 bbl. of oil per each well (taking into account the productive range of each well) that corresponds to about \$3,000,000–\$4,000,000 per well. This price doesn't include gas. In addition, with a use of modern technology, we would be able to minimize the non-removable stock. The number of years of use will depend on an intensity of the well's exploitation.

Now consider a technique of cumulative perforation (gun perforation or shots), and a technique of possible hydraulic fracturing in a same formation condition as it was described above.



If we open such formation using cumulative perforation (or example, gun perforation) we will receive several small diameter holes (~ 50 mm, or 2 inches) at a small depth (~ 250 mm, or 1 foot), also causing casing damage, cement cracks, and clogged borders. Moreover, point perforation does not discharge stress-strain that stays in a formation and concentrates tension itself and constitutes additional "plugs", and thus significantly reduces flow rate. Additional stimulation techniques are required for inflows. Only four out of ten visible interlayers are opened, six productive layers are still remained closed.

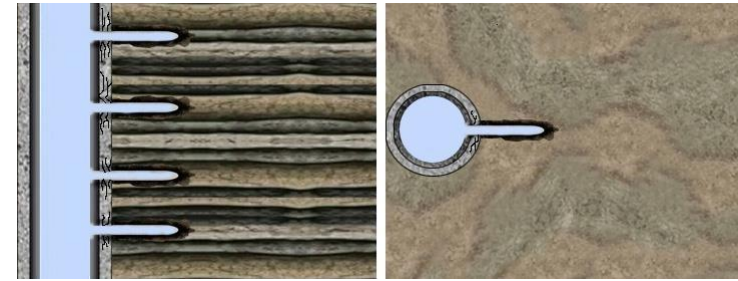

Hydraulic fracturing - is one of the most powerful methods of opening productive and all other formations at once! Hydraulic fracturing is predominantly distributed by most fractured directions, in this case horizontal, since layers are deposited horizontally, and at greater area and distances. Seven out of ten visible interlayers are opened; three layers are still remained closed.

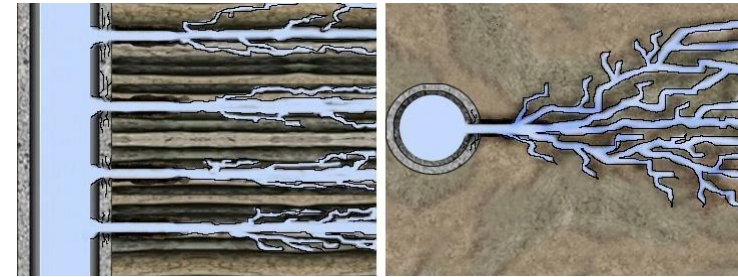

Hydro-slotting perforation (HSP) opens all layers completely. Benefits: no casing damage, no cement cracks, no borders clogging, plus unloading of the annular compressive stress-strain states around the wellbore zone, thus increasing permeability and productive influx. Additional stimulation of inflow is not required. The HSP method is 100% applicable to Caddo field.

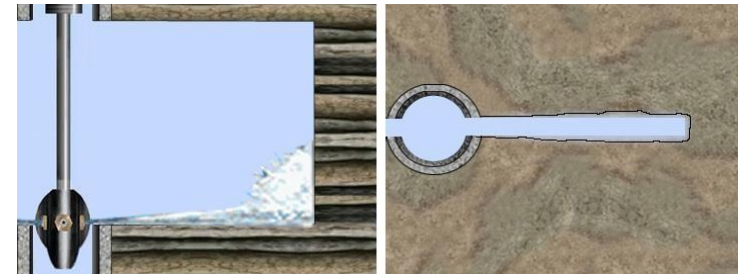



## 3. Comparison of technologies.

There are numerous modern methods of well's recompletion (chemical, mechanical, or combined), with different initial values, efficiency and various duration effects, such as: chemical treatment, additional cumulative perforation, additional stimulation (plasma-pulse), hydraulic fracturing, jet perforation, slotting perforation, etc.

Lasting effects are determined on a basis of an accumulated statistical data, with a cost of various types of recompletion methods from \$30,000-to \$200,000 per well:

- Plasma-pulse stimulation (lasting effect 2.5-6 month, can't be reused because of its damage to a formation in the near wellbore zone);
- Chemical treatment (lasting effect 6-12 month);
- Cumulative perforation (lasting effect 1-3 years);
- Jet perforation (lasting effect 1-3 years);
- Hydraulic fracturing (lasting effect up to 5-8 years);
- HSP: hydro slotting perforation (lasting effect up to 10-15 years and more)

The most productive technologies of wells mechanical recompletion are: hydraulic fracturing and hydro slotting perforation (HSP).

Below is a comparison chart of hydraulic fracturing and slotting perforation:

### HYDRAULIC FRACTURING

Hydraulic fracturing (fracking) - hydraulically pressurized liquid made of water, sand, and chemicals - is known since 1947.

Hydraulic Fracturing is the most powerful method, creating very long cracks and micro cracks spread in the direction of the greatest fracture.

Fracturing relates to methods of opening the productive formation, but it can be applied only after one of the known methods of opening the casing:

- shock-explosive: bullet (gun perforation) and cumulative perforation
- unstressed: methods of point perforation and continuous opening

### HYDRO-SLOTTING PERFORATION

Hydro-slotting perforation - continuous moving jet slotting perforation - is known since 1975 (recommended for industrial use since 1980).

Hydro-slotting perforation is the most effective method of opening the casing, cement and productive formation. For HSP process is used a special slotting perforation tool, that produces linear motion with constant velocity of abrasive cutting jets along the wellbore, and without moving the tubing from the surface.

HSP may be used as a completely independent method for opening casing, cement, productive formation, and receiving the productive inflows. Also HSP can be used in combination with other methods.

### HYDRAULIC FRACTURING

#### Positive aspects:

- very large area of penetration into the productive formation
- large productive inflow (especially in the initial stage)

#### Negative aspects:

- process has practically no control;
- process affects the other layers and zones;
- cracks and micro cracks of large length extend the boundaries of producing formation and transferred to other layers
- coefficient of efficiency sometimes reduced up to 20% (within productive formation), the remaining 80% are harmful
- violation of the integrity of a producing formation
- combining unwanted productive and non-productive reservoirs
- generating unwanted flows
- pulling up the water with subsequent flooding of the productive layer
- reducing the life of the well

Coefficient of efficiency of hydraulic fracturing in shale's or thinly interbedded layers, for example, is very low and financially not beneficial.

### HYDRO-SLOTTING PERFORATION

#### Positive aspects:

- ecologically safe, environmentally friendly (water and sand)
- very long duration of effect (up to 10-15 years and more)
- opportunity of using near the water reservoirs (impossible to make a hydraulic fracturing)
- process is controlled (length and depth of slots)
- process takes place within the productive formation, and not affects other layers and zones
- large opening area, penetration depth is up to 5 feet
- no detonation impact, no casing damage, no cement cracks, no clog-up the formation in borders
- unloading the tangential circle stress conditions in the near wellbore zone up to 50-100%
- increases the collecting properties in the near wellbore zone
- increase of the drainage volume characteristics in more than 6 times
- increase of permeability and accordingly increase the useful inflow up to 30-50%
- opportunity to use in any wells and in any formations

#### Negative aspects:

- process is quite complicated in the performance

Hydro-slotting perforation perfectly working in sandstones and carbonates, thinly interbedded formations, shale's, etc. Coefficient of efficiency of HSP in shale's and thinly interbedded layers is very high.

The following example below shows the use of hydraulic fracturing and hydro-slotting perforation in horizontal well. HSP opens formation within the productive reservoir only, without mixing of productive and non-productive layers.





## 4. Technique.

Given the characteristics of considered wells (Caddo field), and in order to save on some of possible repeating processes, the following steps for each well recompletion process are suggested:

- cleaning and preparation of the well-site
- mobilization and installation of rig with crew
- delivery of tubing and wellhead
- disassembly of pump-jack and lifting up all underground (wellbore) equipment
- wellhead installation, surface piping of the well
- delivery of water tank
- passage wellbore by scraper and caliber
- wireline service, logging



Based on obtained log correction of productive intervals, identify the potential water leaks and cement conditions. Depending on the results of the logging:

- continued preparation of well for hydro-slotting perforation process, or
- repair of cement to prevent possible water flows

If the cement sheath around the wellbore area in the potential cutting intervals is in normal condition, continue preparation of well for hydro-slotting perforation process.

- mobilization and installation of frack (pump) service with frack-van (monitoring)
- delivery of cutting tank with shaker; Intermediate pump (optional)
- delivery of stationary blender
- high pressure line and manifold block installation
- delivery of sand-truck
- hydro-slotting perforation process
- lifting of the HSP tool/equipment
- flushing the well



If required apply standard procedure of gentle hydraulic fracturing with required retainers; otherwise continue with standard procedure.

- if required, apply chemical treatment bath (10-15% HCL for carbonates) for 24 hours, close well
- swab the water

If the inflow is normal pump-jack installation with further development standard procedure:

- move to the next well.

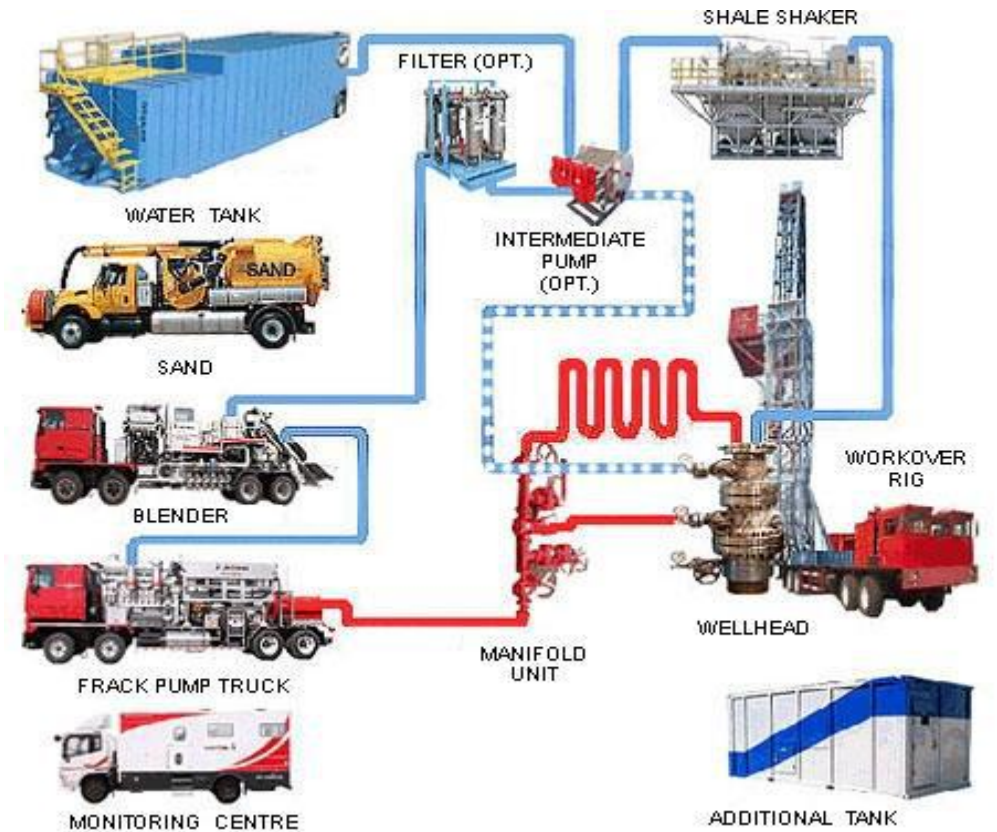



# LOUISIANA. CADDO DEPOSIT FIELD

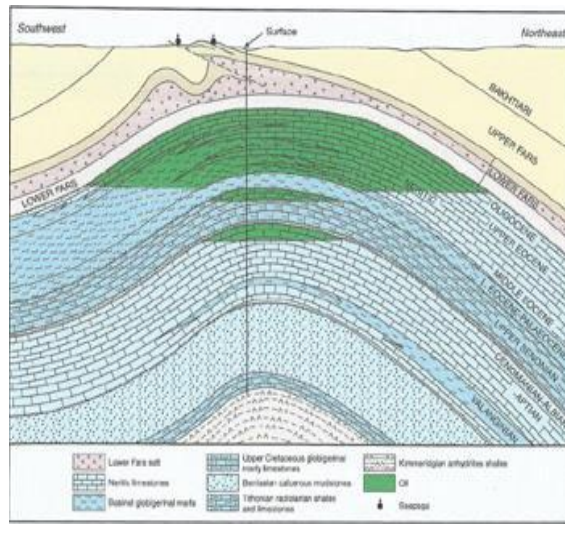
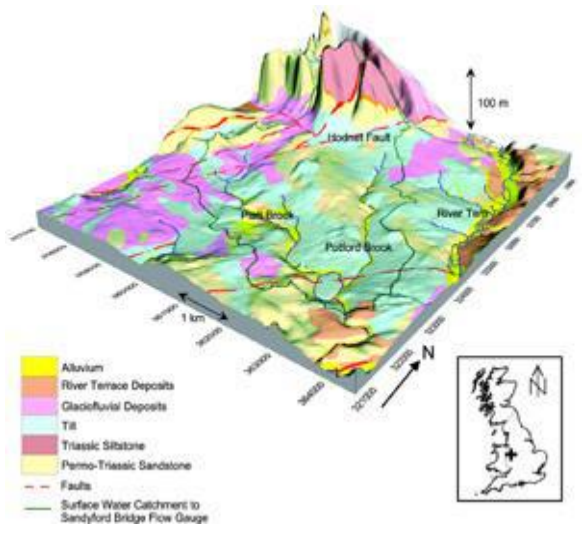
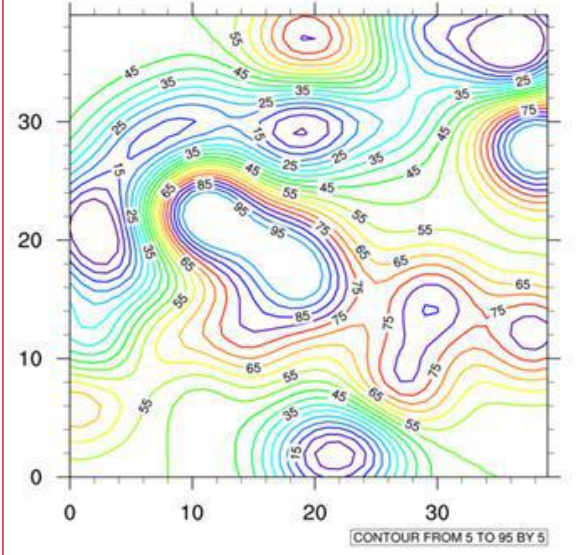
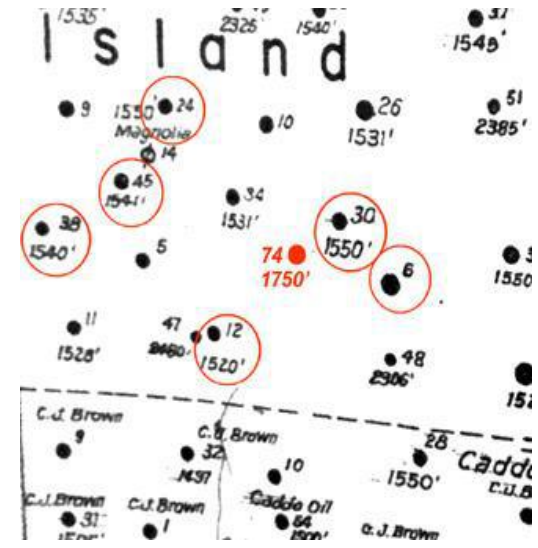

|                  |             |  |
|------------------|-------------|--|
| Clay / Sand      | 0'-68'      |  |
| Rocky Shale      | 68'-118'    |  |
| Shale / Boulders | 118'-365'   |  |
| Sandy Shale      | 365'-504'   |  |
| Shale            | 504'-708'   |  |
| Shale / Lime     | 708'-798'   |  |
| Nacatoch Sand    | 798'-900'   |  |
| Shale            | 900'-1055'  |  |
| Chalk / Shale    | 1055'-1140' |  |

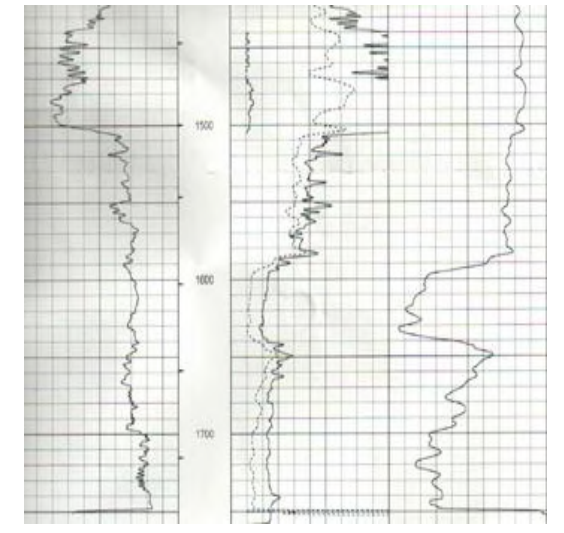





# Geophysical and Geological analysis. Technical Program for HSP well re-completion.

|                  |  |
|------------------|--|
| <b>1</b>         | <b>Collect/purchase/sorting/processing of necessary information:</b>   |
| <b>a</b>         | <b>Well operation/exploitation history (production data)</b>   |
|                  | <ul style="list-style-type: none"> <li>monthly/daily productive inflow of oil, gas and water</li> <li>number of productive and non-productive days per month</li> <li>start and end (maximum and minimum) debit</li> <li>tubing pressure (internal pressure of productive formation)</li> <li>extent the fall of productive inflow</li> <li>stops and possible transitions to the next productive intervals</li> </ul>   |
| <b>b</b>         | <b>All possible logging (logs)</b>   |
|                  | <ul style="list-style-type: none"> <li>induction (electric) log</li> <li>neutron and gamma-ray</li> <li>acoustic (casing/cement) log</li> <li>mud-log, chat-log</li> </ul>   |
| <b>c</b>         | <b>Well information/documentation</b>  |
|                  | <ul style="list-style-type: none"> <li>design/construction (depths, casing (OD/ID))</li> <li>opened productive intervals</li> <li>techniques of opening the productive formations (casing, cement, productive formation)</li> <li>using of hydraulic fracturing, chemical treatment, stimulation, etc.</li> <li>previous closing and transitions to new productive intervals</li> <li>packers, retainers, cementation, insulation/waterproofing, etc.</li> </ul> |
| <b>d</b>         | <b>All possible tests results</b>  |
|                  | <ul style="list-style-type: none"> <li>oil</li> <li>gas</li> <li>water</li> <li>pressure</li> </ul>  |
| <b>e</b>         | <b>Well position map (preferably with an altitude)</b>   |
|                  | <ul style="list-style-type: none"> <li>position (distance) relative to the neighboring oil wells</li> <li>position (distance) relative to the nearest injection wells</li> </ul>   |
| <b>f</b>         | <b>Core analysis, lithology, etc. (core)</b>   |
|                  | <ul style="list-style-type: none"> <li>core analysis</li> <li>rock sample's pictures</li> <li>previous geology, lithology, core analysis</li> </ul>  |
| <b>\$ 500.00</b> |  |

|                  |   |
|------------------|---|
| <b>2</b>         | <b>Geophysical and Geological analysis for HSP well's re-completion:</b>  |
| <b>a</b>         | <b>Location of well's position in the deposit-field</b>   |
|                  | <ul style="list-style-type: none"> <li>well's map position relative to the neighboring oil/injection's wells</li> <li>major characteristics of producing field</li> </ul>   |
| <b>b</b>         | <b>Geological and Geophysical structure/structures</b>  |
|                  | <ul style="list-style-type: none"> <li>core, lithology, rock, formations</li> <li>porosity, permeability, pore's structure</li> <li>oil, gas and water saturation</li> </ul>  |
| <b>c</b>         | <b>Design and Logging</b>   |
|                  | <ul style="list-style-type: none"> <li>logging (induction (electric), neutron and gamma-ray, acoustic (casing/cement), mud-log, chat-log)</li> <li>correlation with neighboring oil/injection's wells</li> <li>lithological analysis</li> </ul> |
| <b>d</b>         | <b>Summary analysis of geological and geophysical data</b>  |
|                  | <ul style="list-style-type: none"> <li>perspective productive Intervals</li> <li>recommended for HSP cutting productive intervals</li> <li>pressure</li> </ul>  |
| <b>e</b>         | <b>Prospects analysis</b>   |
|                  | <ul style="list-style-type: none"> <li>residual stock analysis by cumulative production method</li> <li>prospects analysis after HSP re-completion</li> </ul>   |
| <b>\$ 500.00</b> |   |

|                  |   |
|------------------|---|
| <b>3</b>         | <b>Technical Project ("Cut Program", specification, schedule)</b>   |
| <b>a</b>         | <b>Calculation of technological parameters for HSP re-completion</b>  |
|                  | <ul style="list-style-type: none"> <li>Initial data</li> <li>calculation of technological parameters</li> <li>results of calculation of technological parameters</li> </ul>   |
| <b>b</b>         | <b>Technical Parameters</b>   |
|                  | <ul style="list-style-type: none"> <li>flow control valve</li> <li>pressure-temperature-cutting speed dependence</li> <li>nozzles, erosion, rate, connections</li> <li>surface equipment scheme</li> <li>hydro-slotting perforation process graph</li> </ul>  |
| <b>c</b>         | <b>Hydro-slotting perforation Program</b>   |
|                  | <ul style="list-style-type: none"> <li>preparation for slot perforation process</li> <li>hydro-slotting perforation (HSP) process</li> <li>start- ending of HSP process</li> <li>possible violations of HSP process</li> <li>hydro-slotting perforation (HSP) technical schedule</li> </ul>                         |
| <b>d</b>         | <b>Safety and operational requirements</b>  |
|                  | <ul style="list-style-type: none"> <li>emergency medical response procedure</li> <li>fire emergency procedure</li> <li>spill or release procedure</li> <li>H2S emergency procedure</li> <li>emergency response for storm</li> <li>response to a bomb threat</li> <li>emergency medical information forms</li> </ul> |
| <b>\$ 500.00</b> |   |



Example of Geophysical and Geological analysis, and Technical Program for HSP well re-completion:  
<http://www.maxxwell.net/10-15.pdf>

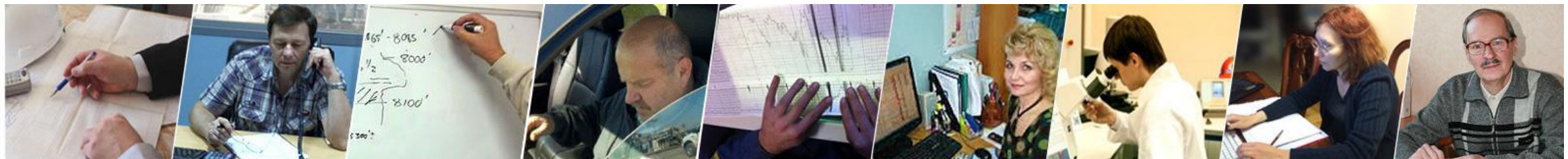



# Preparation, preparatory, and HSP process expenses.

(based for standard HSP process during 10 days (2 days HSP process), with two HSP tool/equipment sets, and performed by two HSP experts)

|   |   |             |    |                     |
|---|---|-------------|----|---------------------|
| <b>1 Preparation of Hydro-slotting Perforation (HSP) tool/equipment</b>                   |   |             |    |                     |
| <b>a Consumable and spare parts for HSP tool/equipment</b>                                |   |             |    |                     |
|   | • Perforator MAXXWELL-P120ES4-D-1/2 (ergonomic one piece solid metal D-1/D-2 for 4/2 nozzles and ball valve seat)                         | \$ 2,500.00 | 2  | \$ 5,000.00         |
|   | • Nozzle MAXXWELL-NL1-07-06-0.2CONE   | \$ 150.00   | 8  | \$ 1,200.00         |
|   | • Nozzle-holder (hardy/T <sup>o</sup> ) MAXXWELL-NH1.2-1-1  | \$ 130.00   | 8  | \$ 1,040.00         |
|   | • Plug/cup (one piece solid metal D-1/D-2)  | \$ 120.00   | 4  | \$ 480.00           |
|   | • Copper sealing ring MAXXWELL-CR0.1  | \$ 25.00    | 8  | \$ 200.00           |
|   | • Spring (for return unit) MAXXWELL-SP70X2.5  | \$ 1,000.00 | 1  | \$ 1,000.00         |
|   | • Sinter metal valve ball to test the tightness of tubing connections   | \$ 300.00   | 1  | \$ 300.00           |
|   | • Steel valve ball for HSP perforator   | \$ 10.00    | 5  | \$ 50.00            |
|   | • Hydraulic oil "MAXXWELL-T" low temperature dependence of the viscosity  | \$ 35.00    | 4  | \$ 140.00           |
|   | • Grease "MOBILE" for medium and high temperatures  | \$ 10.00    | 12 | \$ 120.00           |
|   |   |             |    | <b>\$ 9,530.00</b>  |
| <b>b Preparation of HSP tool/equipment</b>  |   |             |    |                     |
| Preparation of two HSP tool/equipment sets for each working day (two installer x 10 days) |   |             |    |                     |
|   | • assembly-disassembly, cleaning, inspection, adjustment  | \$ 2,500.00 | 2  | \$ 5,000.00         |
|   | • installation and adjustment of control flow device for required temperature   |             |    |                     |
|   | • assembly-disassembly, testing HSP tool/equipment under required pressure and temperature, drawing up a table of measurements            |             |    |                     |
|   | • drawing up the individual graph of dependence for pressure, temperature, and cutting speed, separately for each HSP tool/equipment sets |             |    |                     |
|   | • packaging/conservation  |             |    |                     |
|   |   |             |    | <b>\$ 5,000.00</b>  |
|   |   |             |    | <b>\$ 14,530.00</b> |

|  |   |             |     |                     |
|--|---|-------------|-----|---------------------|
| <b>2 Well re-completion process with HSP Technology (directly on the well-site)</b>    |   |             |     |                     |
| <b>a Trip/travel expenses (two HSP experts x 10 days)</b>                              |   |             |     |                     |
|  | • fuel/transport/service expenses (trip + local)  |             |     | \$ 1,000.00         |
|  | • shipping/delivery, and other unexpected but possible expenses (loading and unloading, assistants expenses, etc.)                            |             |     | \$ 500.00           |
|  | • accommodation (nearest hotel/motel, RV/trailer, mobile house) (2 experts)   | \$ 100.00   | 10  | \$ 1,000.00         |
|  | • meal/food (2 experts x \$ 50/day)   | \$ 100.00   | 10  | \$ 1,000.00         |
|  | • temporary space for travel laboratory (including electricity, water, heating/ air conditioning, communication, internet, work desks, etc.)  | \$ 200.00   | 10  | \$ 2,000.00         |
|  |   |             |     | <b>\$ 5,500.00</b>  |
| <b>b Well re-completion process with HSP Technology (directly on the well-site)</b>    |   |             |     |                     |
|  | • organization of well-site, necessary services and service-companies, tool/equipment and materials, consumable and spare parts, etc.         | \$ 2,500.00 | 2   | \$ 5,000.00         |
|  | • supervision/management, engineering, control, coordination and monitoring the whole HSP process, accident prevention (from start to end)    |             |     |                     |
|  | • completion of the process, assembly-disassembly, cleaning, inspection of HSP tool/equipment, packaging/conservation, cleaning of work-space |             |     |                     |
|  | • well further exploitation recommendations   |             |     |                     |
|  |   |             |     | <b>\$ 5,000.00</b>  |
|  |   |             |     | <b>\$ 10,500.00</b> |
| <b>Sum</b>   |   |             |     | <b>\$ 25,530.00</b> |
| <b>3 Amortization coefficient (other additional amortization and current expenses)</b> |   |             |     |                     |
| <b>a Amortization coefficient (for each well)</b>                                      |   |             |     |                     |
|  | • Amortization coefficient for HSP service (description on the next page)   |             | 10% | \$ 2,553.00         |
|  |   |             |     | <b>\$ 2,503.00</b>  |
| <b>Total</b>   |   |             |     | <b>\$ 27,533.00</b> |

Example of invoice for standard well re-completion Geophysical and Geological analysis, and Technical Program for HSP well re-completion:

<http://www.maxxwell.net/Invoice.pdf>





# Amortizations and current expenses.

Maxwell Production does not charges any additional fees for Geophysical and Geological analysis (only salary analysts), consumable and spare parts (manufacturer price), preparation HSP tool/equipment (only salary installers), and HSP re-completion process (only salary experts), therefore, to maintain the company in a good condition we are forced to charge a symbolic percentage for amortizations and current expenses.

|          |  |
|----------|--|
| <b>1</b> | <b>Consumption of amortization percentage (amortization and current expenses) - 10% from service (approximately \$ 2,000.00 - \$ 3,000.00 from each well)</b>  |
| <b>a</b> | <b>Office, workshop, laboratory expenses</b>   |
|          | <ul style="list-style-type: none"> <li>office, workshop, laboratory leases</li> <li>electricity, water, gas, Internet, communications, security, CCTV furniture and office equipment (computers, printers, copier, scanner, coffee maker, fridge, etc.</li> <li>consumables materials for office, workshop and laboratory</li> <li>office staff and helpers salary</li> </ul>  |
| <b>b</b> | <b>Transport</b>   |
|          | <ul style="list-style-type: none"> <li>gasoline</li> <li>service and maintenance</li> <li>consumables materials and spear parts</li> <li>purchase of additional transport</li> </ul>   |
| <b>c</b> | <b>Tool/equipment</b>  |
|          | <ul style="list-style-type: none"> <li>manufacture and replacement of HSP tool/equipment parts</li> <li>manufacture of new HSP tool/equipment</li> <li>manufacture of special tool/equipment</li> <li>purchase of a new tool/equipment</li> <li>working consumables materials for workshop and laboratory</li> </ul>   |
| <b>d</b> | <b>Research, development and improvement</b>   |
|          | <ul style="list-style-type: none"> <li>styling/design, engineering/development, planning/projecting</li> <li>calculations, mathematical and physical tests/analysis</li> <li>prototyping and testing, improvement, introduction of new models</li> <li>writing and implementation of new applications and patents</li> <li>creating computer programs, publication of scientific articles</li> <li>participation in scientific conferences, forums, special exhibitions</li> </ul> |

|          |  |
|----------|--|
| <b>e</b> | <b>Permits, licenses, certifications, insurances</b>   |
|          | <b>Professional Service Liability Insurance</b>  |
|          | <b>Commercial General Liability</b>  |
|          | <ul style="list-style-type: none"> <li>Body Injury</li> <li>Property damage</li> <li>Inclusive limits</li> <li>Products Completed Operations</li> <li>Personal &amp; Advertising Injury</li> </ul> |
|          | <b>Pollution Liability</b>   |
|          | <ul style="list-style-type: none"> <li>Aggregate Limit</li> <li>Per each Incident</li> </ul>   |
|          | <b>Umbrella Liability</b>  |
|          | <ul style="list-style-type: none"> <li>Aggregate Limit</li> <li>Per Occurrences Limit</li> </ul>   |
|          | <b>Control of Well Insurance</b>   |
|          | <ul style="list-style-type: none"> <li>Each Occurrences</li> <li>Combined Single Limit</li> <li>Each Occurrences</li> </ul>  |
|          | <b>Personal insurance</b>  |
|          | <ul style="list-style-type: none"> <li>medical insurance policy</li> <li>travel medical insurance policy</li> </ul>  |
|          | <b>Periodic training, testing and examinations</b>   |
|          | <ul style="list-style-type: none"> <li>Safe land USA</li> <li>H2S Awareness Certificate</li> <li>WHIMS Workplace Hazardous Materials Information System Certificate</li> </ul>                     |

|          |  |
|----------|--|
|          | <ul style="list-style-type: none"> <li>TDG Transportation of Dangerous Goods by Ground Certificate</li> <li>IADC Rig Pass</li> <li>First Aid Certificate</li> </ul>  |
| <b>f</b> | <b>Safety and PPE (special personal protective equipment)</b>  |
|          | <ul style="list-style-type: none"> <li>Active and tested H2S Gas Indicator to determine the level of permissible (fatal) values of toxic gases</li> <li>Special protective body suit (dielectric, oil-resistant, non-flammable, protection level # 2 minimum)</li> <li>Personal protective helmet</li> <li>Personal protective boots</li> <li>Personal protective rubber boots</li> <li>Personal protective glasses</li> <li>Personal protective gloves</li> <li>Personal protective rubber gloves</li> <li>Personal protective Face Shield (protect the entire face area from chemical splashes and flying objects)</li> <li>Personal protective Dust Mask (protect from inhaling airborne dust particles, fibers or mechanically generated particles)</li> <li>Personal protective Cartridge Respirator (protect from airborne contaminants and toxic gases)</li> <li>Personal protective Self Contained Breathing Apparatus (protect when require oxygen during hazard assessment)</li> </ul> |
| <b>g</b> | <b>Marketing and Advertising</b>   |
|          | <ul style="list-style-type: none"> <li>creation and maintenance of websites and advertisings</li> <li>technical conferences, meetings, presentations, exhibitions</li> <li>research for potential customers, negotiations, consultations</li> <li>business correspondence, conclusion of contracts and agreements</li> </ul>   |
| <b>h</b> | <b>Education and training of new HSP Technology specialists/experts</b>  |





# Third-party services and equipment, necessary for well re-completion with HSP Technology.

(approximate prices, can vary depending on the complexity of the project)

|   |  |                      |                     |
|---|--|----------------------|---------------------|
| <b>1 Services and supplies</b>                  |  |                      |                     |
| <b>a Well-site preparatory and organization</b> |  |                      |                     |
|   | Site work: preparation & maintenance (cleaning/leveling/strengthening, access roads/driveways, digging trenches/reservoir, fencing: attention tapes and warning signs/posters, supervisor/command post with communication, CB-radio, safety equipment, first aid, PPE, H <sub>2</sub> S equipment, wind direction flag, arrange an immediate challenge (if necessary) of police, ambulance, fire service, environment service, etc.) |                      | \$ 690.00           |
|   | tractor/bulldozer/small excavator  |                      | \$ 375.00           |
|   |  |                      | <b>\$ 1,065.00</b>  |
| <b>b Equipment and supplies (10 days)</b>       |  |                      |                     |
|   | wellhead (wellhead top hole equipment with standard BOP)   |                      | \$ 750.00           |
|   | surface piping, connections, low pressure line   |                      | \$ 420.00           |
|   | misc., valves, fittings, joint-pipes   |                      | \$ 130.00           |
|   | tubing: 2-7/8"(or 3-1/2") (correction according to the program)  | \$ 1.85/foot x 4000' | \$ 7,400.00         |
|   | rods - (D grade) @ (correction according to the program) rental  |                      | \$ 780.00           |
|   | scraper and caliber (4.0" or 5.0") (correction according to the program)   | \$ 120.00+\$ 150.00  | \$ 270.00           |
|   | water tank (water hauling) (300 bbl.)  |                      | \$ 515.00           |
|   | brine (formation/layer) water (with delivery)  |                      | \$ 585.00           |
|   | cutting tank (cut tank/shale shaker) with vibrator (180 bbl.)  |                      | \$ 1,510.00         |
|   | empty tank (empty hauling) (200 bbl.)  |                      | \$ 340.00           |
|   | 40 intermediary pumping unit w/ 7.5 HP motor   |                      | \$ 155.00           |
|   | abrasive quartz sand 20/40 (optional 10/35) (optional garnet sand) w/delivery  | \$ 455.00 x 38 ton   | \$ 17,290.00        |
|   |  |                      | <b>\$ 30,145.00</b> |
| <b>c Wellsite Supervision/Engineering</b>       |  |                      |                     |
|   | wellsite Supervisor  | \$ 535/day x 10 days | \$ 5,350.00         |
|   | wellsite Engineer  | \$ 258/day x 10 days | \$ 2,580.00         |
|   | wellsite Safety Manager  | \$ 125/day x 10 days | \$ 1,250.00         |
|   |  |                      | <b>\$ 9,180.00</b>  |

|   |  |                     |                      |
|---|--|---------------------|----------------------|
| <b>d Services and equipment</b>   |  |                     |                      |
| Workover (Rig + rig's pump + team/stuff)  |  |                     |                      |
|   | Workover (Rig + team/staff + Labor: installation/construction/re-completion)                 | \$2750/day x10 days | \$ 27,500.00         |
| Wireline logging service  |  |                     |                      |
|   | Cased hole logging (neutron/gamma-ray, acoustic/casing logging)                              |                     | \$ 5,730.00          |
| Fracking (pumping) service with crew  |  |                     |                      |
|   | Triplex Plunger Pump (up to 6000 psi pressure, and up to 10000 bbl./min rate)                |                     | \$ 26,250.00         |
|   | Frack-van (monitoring center)  |                     | -                    |
|   | high pressure line, connections, misc., valves, fittings, joint-pipes                        |                     | -                    |
|   | Manifold-block (direct-back flushing)  |                     | \$ 250.00            |
|   | Blender track (or mobile mixer)  |                     | \$ 545.00            |
|   | Pressure, flow rate, density, concentration, temperature sensors (indicators)                |                     | -                    |
| Trucking, Hauling, Winch truck, electricity service, delivery service, clean-up service |  |                     |                      |
|   | Trucking, Hauling, Winch truck, electricity/fuel service, delivery service, clean-up service |                     | \$ 350.00            |
| Acid treatment service  |  |                     |                      |
|   | Acid treatment service (5,000 gallon acetic acid Job)  |                     | \$ 3,570.00          |
| Completion works  |  |                     |                      |
|   | pumping (swabbing) water from the well until produce productive inflows                      |                     | \$ 1,660.00          |
|   | completion unit  |                     | -                    |
| Downhole Pump & Accessories service   |  |                     |                      |
|   | downhole pump (pump-jack) & accessories service  |                     | \$ 625.00            |
|   | downhole rod, downhole pump, electric motor, starter control box                             |                     | \$ 1,170.00          |
| Other possible potential unaccounted operating costs and administrative expenses        |  |                     |                      |
|   |  |                     | -                    |
|   |  |                     | <b>\$ 67,650.00</b>  |
|   |  |                     | <b>\$ 108,040.00</b> |
| <b>Contingencies</b>  |  |                     |                      |
|   | contingencies coefficient (5%)   |                     | \$ 5,402.00          |
|   |  |                     | <b>\$ 113,442.00</b> |





# Additional operations and expenses, if it recommended after Geophysical and Geological analysis

(Additional operations determined according to the results of Geophysical and Geological analysis)

**Hydro-slotted perforation** opens the whole zone of productive layer (all the pores of matrix), forms an excellent hydrodynamic connection well with the productive formation, unloads stress conditions in the near wellbore area and improves reservoir properties (increases the permeability and improves porosity). HSP increases productive inflow in dozens of times with lasting positive effect 10-15 years. However, this is not the limit. There are additional operations that can still increase the percent of productive inflow.

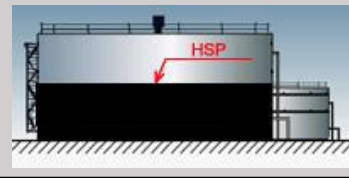

|                 |  |
|-----------------|--|
| <b>PROBLEM</b>  | <b>Cement ring in a bad condition</b> (cracks and micro cracks)  |
| <b>CAUSE</b>    | Bad cement composition, or cement cracked from long time of exploitation, cement cracked in resulting of use cumulative perforation and subsequent hydraulic fracturing      |
| <b>AFFECT</b>   | Cracks and micro cracks are forms capillary movement of water from water reservoirs to the productive layer, that leads to very rapid water flooding the producing formation |
| <b>RISK</b>     | If the borehole located near the water reservoirs, there is a risk of very rapid water flooding the producing formation  |
| <b>SOLUTION</b> | Repair cement ring or isolation packers watered productive interval, and transition to another productive interval (if there)  |

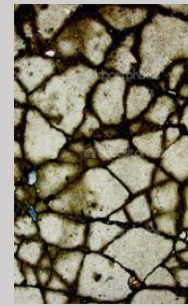

| a REPAIR of cement sheath |   |                      |                     |
|---------------------------|---|----------------------|---------------------|
|                           | • setting of packer (retainer) (packer-service company)                     | \$ 2,250 x 2         | \$ 4,500.00         |
|                           | • workover (Rig + team/staff + labor)                                       | \$ 2,750/day x 2 day | \$ 5,500.00         |
|                           | • bentonite sealing solution (amount according to the project)              |                      | \$ 1,250.00         |
|                           | • sealing the borehole with bentonite solution                              |                      | -                   |
|                           | • one passage the borehole by scraper + one passage the borehole by caliber |                      | -                   |
|                           |   |                      | <b>\$ 11,250.00</b> |

| b ISOLATION of water flooding interval with permanent non-removable packers or/and cementation |   |                      |                     |
|--|---|----------------------|---------------------|
|  | • setting of packer (packer-service company)                                | \$ 2,250 x 1         | \$ 2,250.00         |
|  | • workover (Rig + team/staff + labor)                                       | \$ 2,750/day x 2 day | \$ 5,500.00         |
|  | • sealing cement bags (amount according to the project)                     |                      | \$ 3,500.00         |
|  | • sealing the borehole with cement  |                      | -                   |
|  | • one passage the borehole by scraper + one passage the borehole by caliber |                      | -                   |
|  |   |                      | <b>\$ 11,250.00</b> |

|  |                                  |  |                     |
|--|----------------------------------|--|---------------------|
|  | • contingencies coefficient (5%) |  | \$ 1,125.00         |
|  |                                  |  | <b>\$ 12,375.00</b> |

## Additional stimulation of productive inflows with PULSED ELECTRIC HYDRAULIC SHOCKS

Additional stimulation of productive inflows with pulsed electric hydraulic shocks is performing after complete Hydro-slotted perforation (HSP) process, and flushing all cut intervals and borehole. It stimulates the formation of more micro cracks, and further increases the area of hydrodynamic contact the well with productive formation. According to statistics, this procedure can stimulate an increase of productive inflow **30%** more from existing).

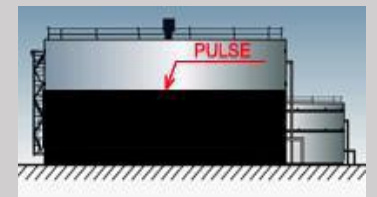

| c Additional stimulation of productive inflows with pulsed electric hydraulic shocks |  |  |                     |
|--|--|--|---------------------|
|  | • Wireline logging service (similar procedure for cased hole logging)            |  | \$ 5,730.00         |
|  | • Pulsed electric hydraulic shocks service (tool/equipment + team/staff + labor) |  | \$ 15,000.00        |
|  |  |  | <b>\$ 20,730.00</b> |

## Additional stimulation of productive inflows with gentle HYDRAULIC FRACTURING

Additional stimulation of productive inflows with gentle hydraulic fracturing (4000 psi) is performing after complete Hydro-slotted perforation (HSP) process, and flushing all cut intervals and borehole. HSP sets a good geometry for subsequent hydraulic fracturing, and stimulates the formation of more extended deep and long cracks and micro cracks, and further increases the area of hydrodynamic contact the well with productive formation. According to statistics, this procedure can stimulate an increase of productive inflow **60%** more from existing).

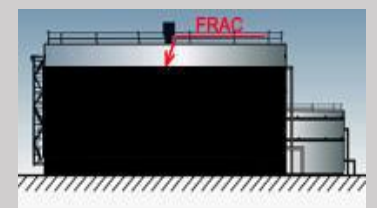

| d Additional stimulation of productive inflows with gentle hydraulic fracturing |   |                      |                     |
|---|---|----------------------|---------------------|
| Workover (Rig + rig's pump + team/stuff)  |   |                      |                     |
|   | • Workover (Rig + team/staff + Labor: installation/construction/re-completion)  | \$ 2,750/day x 1 day | \$ 2,750.00         |
| Fracking (pumping) service with crew  |   |                      |                     |
|   | • Triplex Plunger Pump (up to 6000 psi pressure, and up to 10000 bbl./min rate) |                      | \$ 15,850.00        |
|   | • Frack-van (monitoring center)   |                      | -                   |
|   | • high pressure line, connections, misc., valves, fittings, joint-pipes         |                      | -                   |
|   | • Manifold-block (direct-back flushing)   |                      | \$ 250.00           |
|   | • Blender track (or mobile mixer)   |                      | \$ 500.00           |
|   | • Proppant (sticky sand sand) with delivery                                     | \$ 500.00 x 18 ton   | \$ 9,000.00         |
|   | • abrasive quartz/glass sand (optional garnet sand) with delivery               | \$ 300.00 x 12 ton   | \$ 3,600.00         |
|   | • setting of packer/retainer (one passing) (packer-service company)             | \$ 2,250 x 2 packers | \$ 4,500.00         |
|   |   |                      | <b>\$ 36,450.00</b> |
|   | • contingencies coefficient (5%)  | \$ 1,125.00          | \$ 3,645.00         |
|   |   |                      | <b>\$ 40,095.00</b> |

**CORRESPONDENCE**

616 Corporate Way 2, # 4201  
Valley Cottage, NY  
United States 10989

**CORRESPONDENCE**

848 N. Rainbow Blvd., # 5353  
Las Vegas, NV  
United States 89107

**CORRESPONDENCE**

11555 US-380, # 205  
Krum, TX  
United States 76249

**PHONES**

Toll free: 1-800-696-5721  
Tel: (940) 368-1192  
(647) 724-4308

**EMAILS**

info@maxxwell.us  
info@maxxwell.ca  
info@maxxwell.net

**INTERNET**

www.maxxwell.us  
www.maxxwell.ca  
www.maxxwell.net